



Yangzhou Decano Solar Lighting Co., Ltd

- ☎ 0086 166 5109 9987
- ✉ sales@dcnsolar.com
- 🌐 www.dcnSolar.com
- 📍 No. 208, Jinliu Avenue, Guoji, Songqiao Town, Gaoyou City, Jiangsu Province, China.

Version No: 25.2



PRODUCT CATALOG

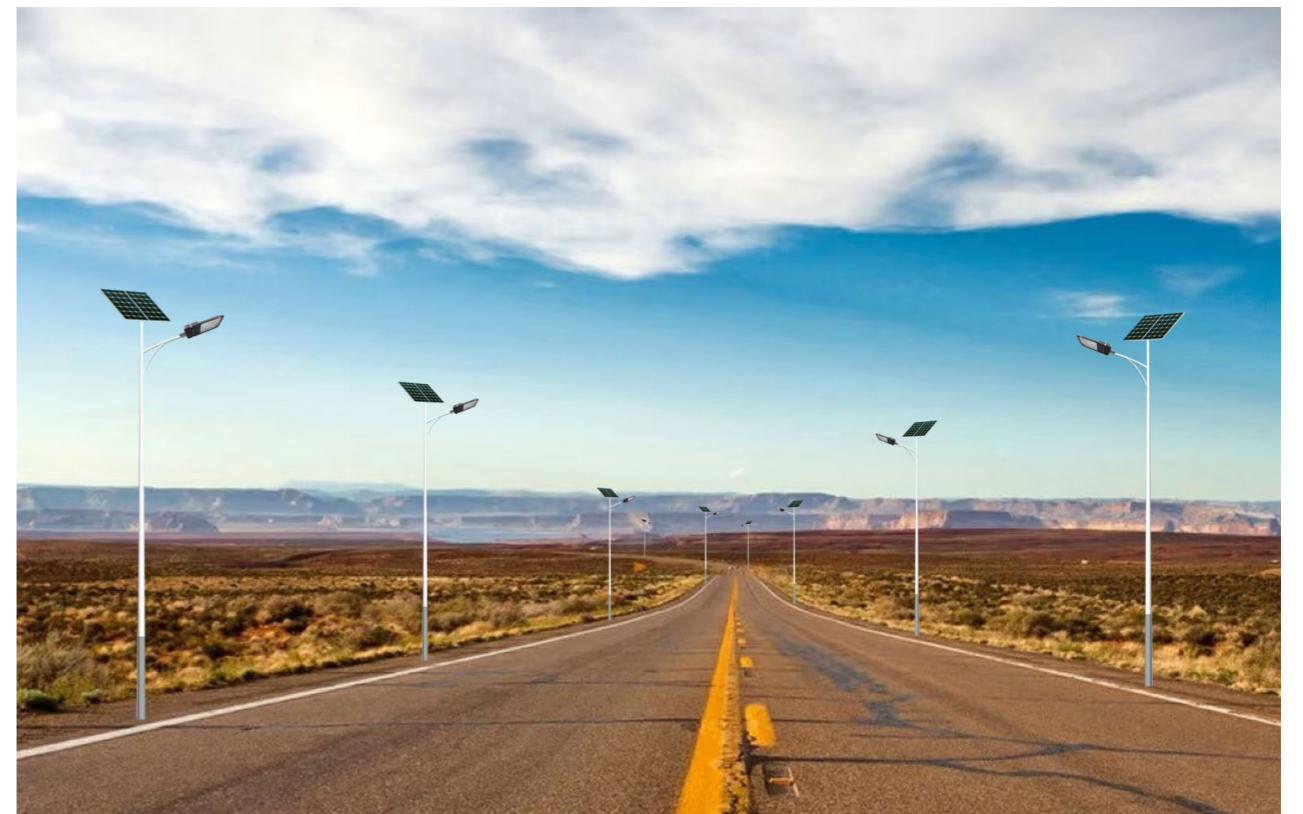

Company Profile

We are a professional manufacturer of outdoor lighting facilities.

We own 40000m² workshops of LED lights, solar panels, lithium batteries, and poles, and more than 60 workers, among them, there are 15 technicians, our factory is certified with ISO 9001, and ISO 14001, and products comply with CE, IEC, RoHS, SASO standard. Thinking what you think and caring about what you are concerned about is our service principle, making the best cost-effective products is our product concept.

At our core, we prioritize understanding your needs and addressing your concerns. Our service ethos revolves around empathizing with your perspective and delivering tailored solutions. Additionally, our product philosophy revolves around crafting the most cost-effective offerings without compromising quality. Trust us to illuminate your outdoor spaces with sustainable, dependable, and economically viable solutions.

ONE-STOP LED OUTDOOR LIGHTING MANUFACTURER



QUALIFICATIONS



• Solar Street Light Workshop ----->>



• Light Pole Workshop ----->>



• Laboratory/Exhibition Hall ----->>



CONTENTS

- All in One Solar Street Light ----- 001
- All in Two Solar Street Light ----- 029
- Split Solar Street Light / AC LED Street Light ----- 043
- Solar Light for Home ----- 061
- High Mast Light ----- 065
- Light Pole ----- 075





All in One Solar Street Light

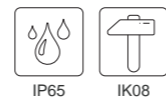

PANTHER 16W/20W/25W/30W/35W



ALL IN ONE SOLAR STREET LIGHT

Adopt high efficiency solar panel for optimal energy conversion.
 Equipped with durable high-capacity batteries to support prolonged illumination.
 Made of heavy-duty materials and weatherproof coating to withstand corrosion, UV exposure and extreme weather.
 Rotatable LED module to meet different installation needs.



Model No.	PANTHER-001		PANTHER-002		PANTHER-003		PANTHER-004	
Rated Power	16W	20W	25W	25W	30W	30W	35W	
Solar Panel	Mono.55W6V	Mono.70W6V	Mono.85W18V	Mono.85W6V	Mono.115W18V	Mono.100W7V	Mono.135W18V	
LiFePO4 Battery	40AH3.2V	50AH3.2V	40AH12.8V	60AH3.2V	50AH12.8V	80AH3.2V	60AH12.8V	
Power Source	5054							
Controller	15A20W	15A20W	10A30W	20A30W	10A40W	20A30W	10A40W	
Light Efficiency	150~190LM/W							
Color Temperature	3000K~6000K							
IP Grade	IP65							
Lamp Pipe Diameter	Φ80MM							
Lamp Dimension	520x840x125MM	520x1005x125MM	520x1070x125MM	520x1205x125MM	520x1370x125MM	520x1390x125MM	520x1515x125MM	
Lamp Weight (Sleeve holder not included)	12.5KG(1pc/CTN)	14.3KG(1pc/CTN)	17.75KG(1pc/CTN)	16.25KG(1pc/CTN)	20.0KG(1pc/CTN)	18.75KG(1pc/CTN)	22.5KG(1pc/CTN)	
Container Weight (Sleeve holder not included)	13.7KG(1pc/CTN)	15.7KG(1pc/CTN)	19.2KG(1pc/CTN)	17.9KG(1pc/CTN)	21.7KG(1pc/CTN)	20.5KG(1pc/CTN)	24.4KG(1pc/CTN)	
Package Dimension	595x915x200MM	595x1080x200MM	595x1145x200MM	595x1280x200MM	595x1445x200MM	595x1465x200MM	595x1590x200MM	
Mount Height	4~6M	4~6M	5~6M	5~6M	6~7M	6~7M	6~8M	
Warranty	3 Years							



Maintenance and inspection can be performed without disassembling the entire light.





FALCON 60W/80W/100W



ALL IN ONE SOLAR STREET LIGHT

Designed for use in engineering environments, capable of withstanding harsh weather and various environmental conditions, ensuring long-term stable operation. Subjected to rigorous quality control and testing, possessing stable and reliable performance, able to work continuously and maintain good lighting effects. Suitable for lighting needs in various engineering projects and outdoor locations such as roads, bridges, construction sites, and parking lots.

*Motion sensor can be selected.

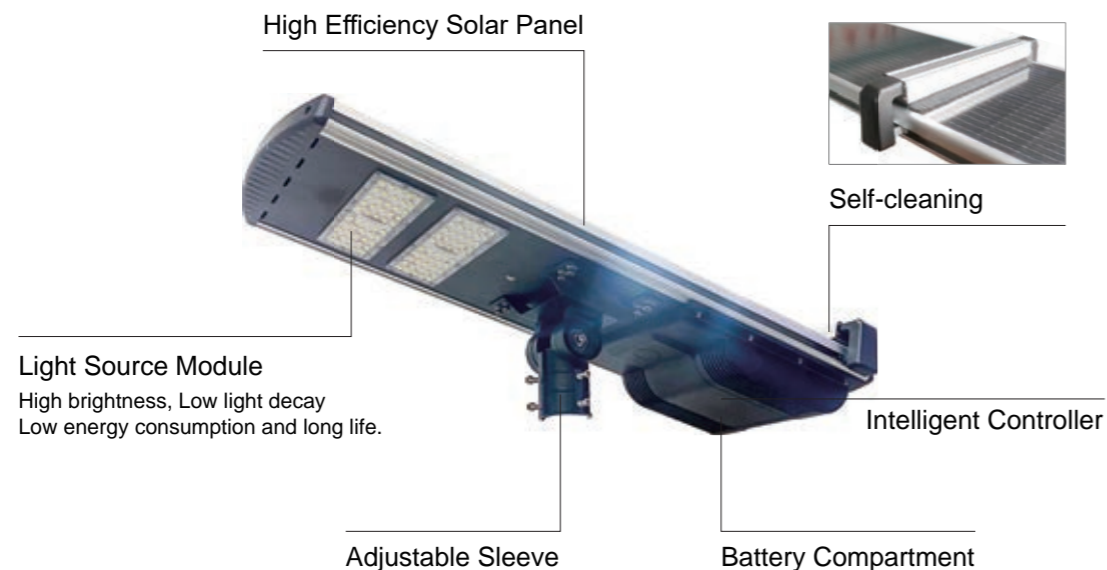

Model No.	FALCON-001	FALCON-002	FALCON-003			
Rated Power	60W	80W	100W			
Material	Die-cast Aluminum + Aluminum Alloy					
Lamp Color	Black Sand Pattern + Frosted Bright Silver					
Light Source	5054					
LiFePO4 Battery	12.8V 32AH	12.8V 40AH	12.8V 48AH			
Controller	30W 10A	40W 10A	50W 10A			
Automatic Cleaning System	Battery of Clean Dusty Parts	11.1V 2AH \	11.1V 2AH \	11.1V 2AH \		
	Frequency of Clean Dusty	1-5 times/day adjustable \	1-5 times/day adjustable \	1-5 times/day adjustable \		
	Clean Dusty Charging	Wireless \	Wireless \	Wireless \		
Solar Panel	18V 60W	18V 80W	18V 100W			
Charging Time	6-8H					
Lighting Time	Adjustable from 6-12 hours					
Opening Method	Button					
Controller	10A30W	10A40W	10A50W			
Lamp Pipe Diameter	Φ82MM					
Installation Height	5-7M	6-8M	7-9M			
Protection Level	IP65					
Number of Boxes	1 pc/CTN					
Package Dimension	1210x495x410MM	1335x495x410MM	1465x495x410MM			
Container Weight	23.5KG	21.95KG	25.35KG	23.8KG	27.5KG	26.3KG
Warranty	3 Years					





ARK 30W



ALL IN ONE SOLAR STREET LIGHT

Achieve a broader illumination range, reduce shadows and dark spots, enhance the three-dimensional feel of lighting, ensure a more stable structure of the lamp, and enable a more flexible lighting layout.

Application: Garden/Yard/Park/Factory/Farm/Court/Square.

Model No.	ARK
Rated Power	30W
Material	PC
Lamp Color	Gray
Power Source	5054
LiFePO4 Battery	3.2V 20AH
Controller	20W 15A
Solar Panel	Poly. 6V 26W
Working Time	6-12H Adjustable
Working Model	Light+Timing+Induction
Pipe Sizes	Φ76mm (Vertical)
Mount Height	3-6M
IP Grade	IP65
Lamp Sizes	650x300x260MM
Package Dimension	770x315x380MM
Lamp Weight	3.9KG
Warranty	3 Years

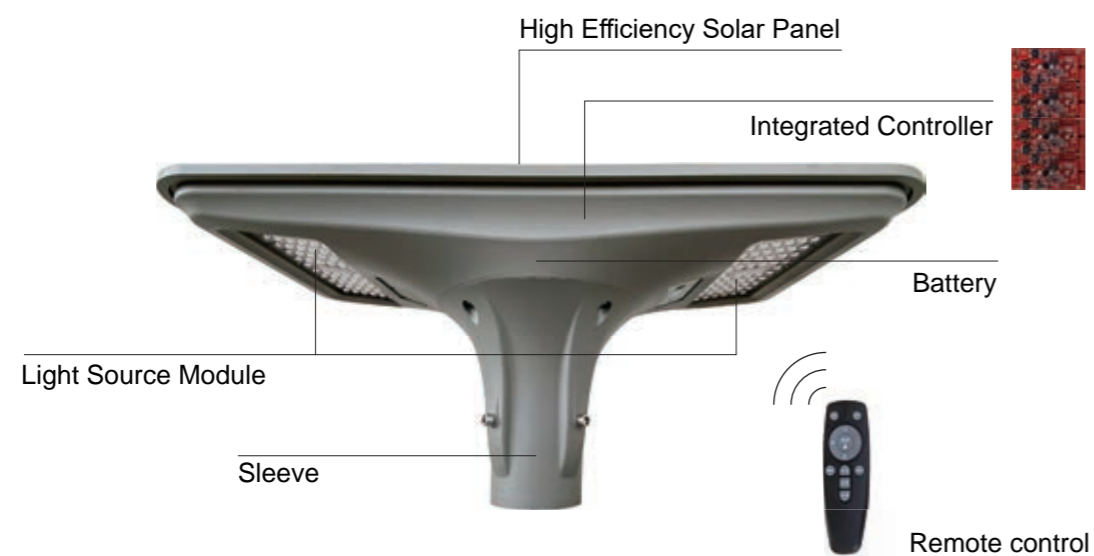



CORE 40W/60W/100W



ALL IN ONE SOLAR STREET LIGHT

Integrated design, easy installation, while the optional universal joint design facilitates adjusting the lighting angle;
 Solar-powered, no need for external power supply, energy-saving and environmentally friendly;
 Automatic light control, long lifespan, low maintenance cost.

Application: Garden/Yard/Park/Factory/Farm/Court/Square

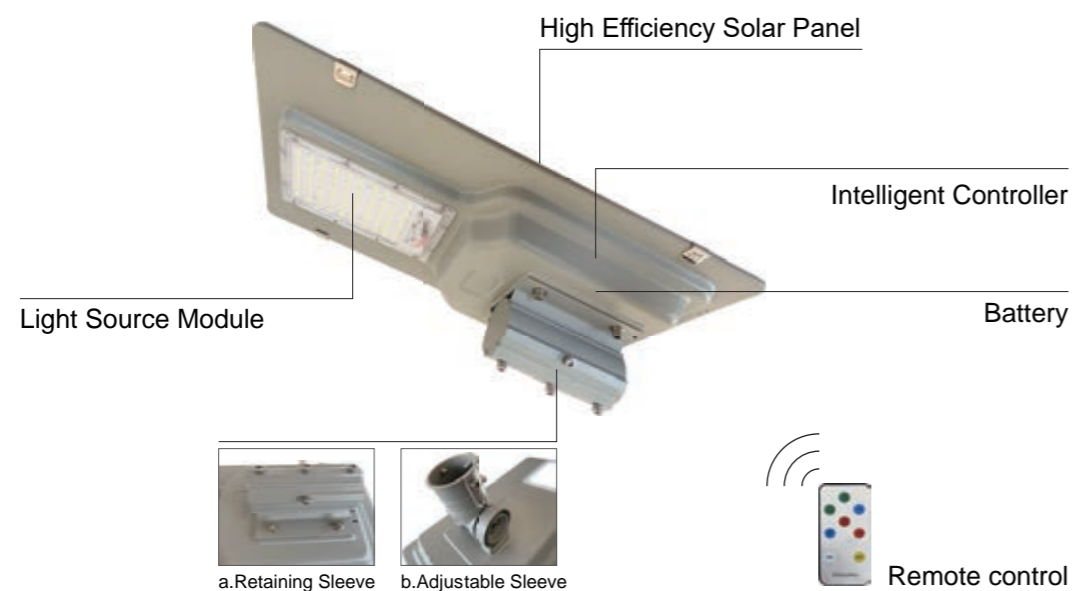

Model No.	CORE-001	CORE-002	CORE-003
Rated Power	40W	60W	100W
Material	Galvanized Plate		
Lamp Color	Light Gray Sand		
Power Source	5050		
LiFePO4 Battery	3.2V 30AH	3.2V 50AH	3.2V 80AH
Controller	20A20W		
Solar Panel	Mono.6V 32W	Mono.6V 40W	Mono.6V 62W
Working Time	6-12H Adjustable		
Working Model	Light+timing, Remote Control		
Pipe Sizes	Φ60/Universal Joint Φ60mm/76mm		
Mount Height	3-4M	4-6M	6-8M
IP Grade	IP65		
Lamp Sizes	600x320x150MM	720x385x150MM	880x400x256MM
Package Dimension	630x375x200MM	730x450x235MM	880x445x215MM
Lamp Weight	a. 4.8KG b. 6.0KG	a. 6.6KG b. 7.8KG	a. 8.4KG b. 8.55KG
Warranty	3 Years		



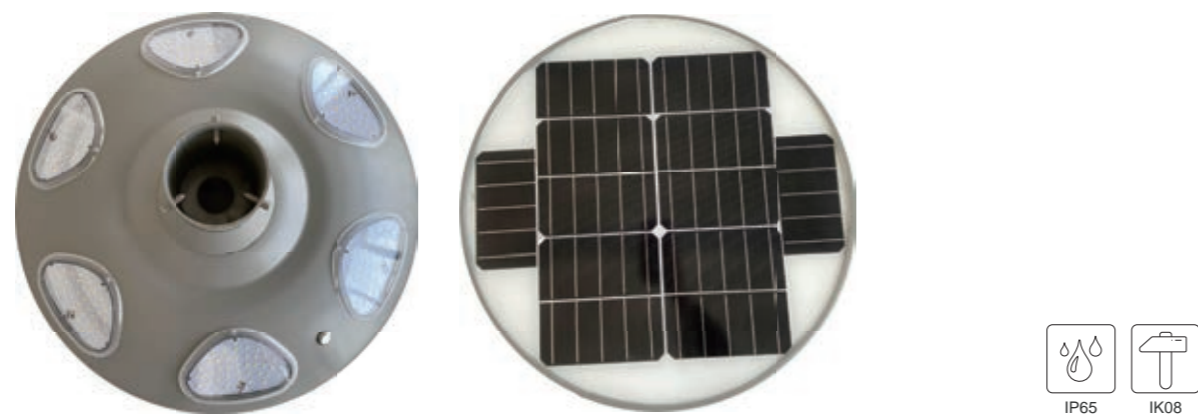

LUNA 6*40W



SOLAR GARDEN LIGHT

Multi-angle illumination, combined with the design of 6 angles to achieve comprehensive lighting coverage, improving the overall lighting effect.
 Solar-powered, no need for external power supply, energy-saving and environmentally friendly.
 Intelligent light control, saving energy, extending the lifespan of the lamp.
 Highly stable structure, ensuring stable operation in various weather conditions, reducing maintenance costs.

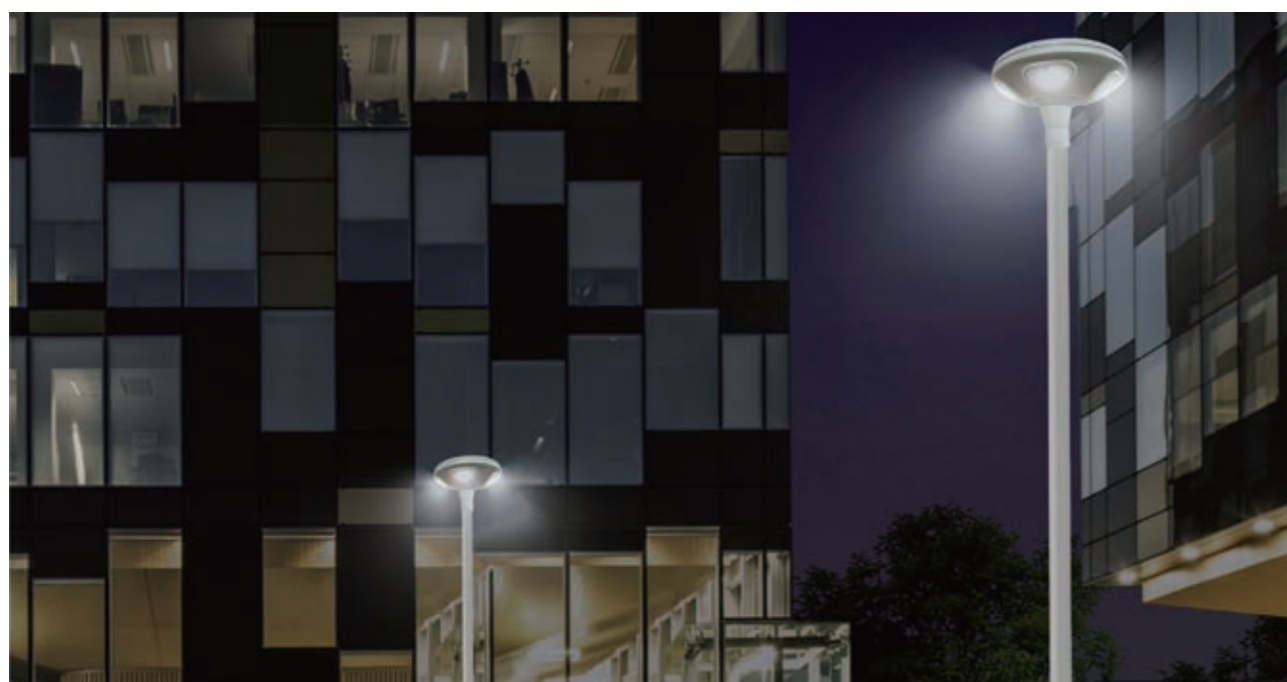

Model No.	LUNA
Rated Power	6*40W
Lamp Color	Light Gray
Power Source	40W*6, 6000K
LiFePO4 Battery	3.2V 20AH
Controller	20W 15A 2.4G
Solar Panel	Mono.30W/6V
Working Time	6-12H
Pipe Sizes	Φ76MM
Mount Height	3-6M
IP Grade	IP65
Lamp Sizes	520x520x220MM
Package Dimension	605x330x620MM
Lamp Weight	5.4KG
Warranty	3 Years



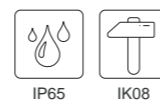

GUARDIAN 5W/8W/15W



ALL IN ONE SOLAR STREET LIGHT

High-efficiency monocrystalline solar panels;
 Stable 3.2V system;
 Well-designed parameters to meet the lighting needs of most scenarios;
 Integrated design with optional sensor devices to control costs effectively.



High Brightness



Hoop



Motion Sensor



Main View

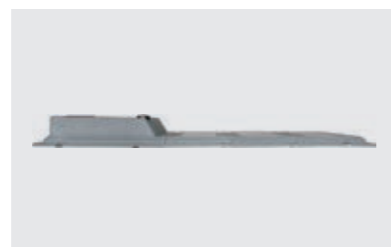

Side View



Top View

Model No.	GUARDIAN-001	GUARDIAN-002	GUARDIAN-003
Rated Power	5W	8W	15W
System Voltage	DC3.2V		
LiFePO4 Battery	12AH	24AH	36AH
Solar Panel	Mono. 16W	Mono. 28W	Mono. 45W
Light Source	3030		
Light Distribution	Bat-Wing light distribution (150°x75°)		
Light Efficiency	150-160LM/W		
Color Temperature	3000K-6000K		
CRI	≥Ra70		
IP Rating	IP65		
Working Temperature	-10°C-+60°C		
LED Lifespan	50000H-100000H		
Controller	10A		
Lamp Pipe Diameter	Φ60MM		
Lamp Dimension	503x233x55MM	598x278x55MM	670x350x55MM
Container Weight	10KG	14KG	20.5KG
Package Dimension (Sleeve not included)	520x165x250MM (4pcs/CTN)	615x165x295MM (4pcs/CTN)	685x165x365MM (4pcs/CTN)
Suggested Mount Height	3-4M	3-4M	4-6M
Warranty	3 Years		



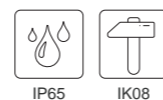

RAY II 18W/25W/30W



ALL IN ONE SOLAR STREET LIGHT

Upgraded the chip level to enhance the light intensity of the fixture,
High-efficiency monocrystalline solar panels,
Integrated design with optional sensor devices to control costs effectively.



High Brightness

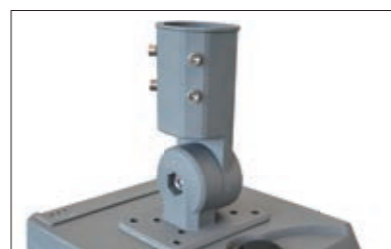

Mounting Sleeve



Motion Sensor

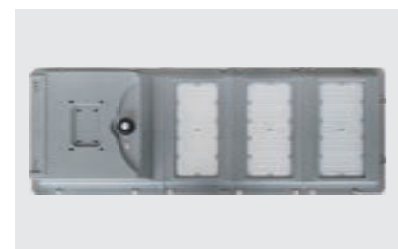

Main View



Side View

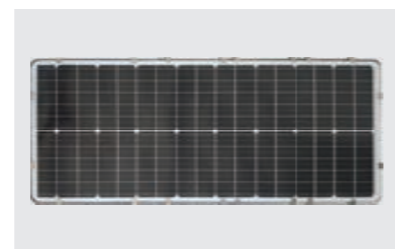

Top View

Model No.	RAY II -001A	RAY II -001B	RAY II -002A	RAY II -002B	RAY II -003A	RAY II -003B
Rated Power	18W		25W		30W	
System Voltage	DC3.2V	DC12.8V	DC3.2V	DC12.8V	DC3.2V	DC12.8V
LiFePO4 Battery	48AH	24AH	60AH	36AH	72AH	48AH
Solar Panel	Mono. 62W	Mono. 64W	Mono. 80W	Mono. 85W	Mono. 100W	Mono. 96W
Light Source	3030					
Light Distribution	Bat-Wing light distribution (150°x75°)					
Light Efficiency	150-160LM/W					
Color Temperature	3000K-6000K					
CRI	≥Ra70					
IP Rating	IP65					
Working Temperature	-10°C-+60°C					
LED Lifespan	50000H-100000H					
Controller	15A20W	6A30W	15A20W	6A30W	15A20W	8A40W
Lamp Pipe Diameter	Φ80MM					
Lamp Dimension	890x405x95MM		1110x405x95MM		1330x405x95MM	
Container Weight	16.5KG	18.9KG	20.6KG	23.6KG	24.3KG	30.3KG
Package Dimension (Sleeve not included)	930x145x420MM (2pcs/CTN)		1150x145x420MM(2pcs/CTN)		1370x145x420MM (2pcs/CTN)	
Suggested Mount Height	4-6M		5-6M		6-7M	
Motion Sensor	Yes					
Warranty	3 Years					



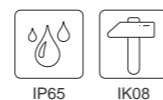

PLATE 20W/40W/50W



ALL IN ONE SOLAR STREET LIGHT

No additional wiring is required, cost saving. Multi-point fixation, stable and durable.
 Direct light-emitting design, high light transmittance protective cover, high light transmittance.
 Human body sensor+light control output.
 High-quality chips, high light efficiency, low light attenuation, and high energy-saving efficiency.
 Designed with a high thermal conductivity aluminum substrate, the entire lamp has good heat dissipation and longer lifespan.

- Multiple mounting options



Hoop Clamp+Support Bracket

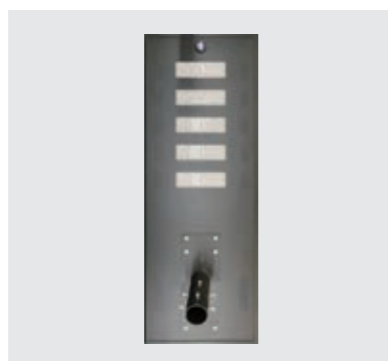

Fixed Inclined Sleeve



Straight Sleeve

Model No.	PLATE-001	PLATE-002	PLATE-003
Rated Power	20W	40W	50W
System Voltage	DC12.8V	DC12.8V	DC12.8V
LiFePO4 Battery	24AH	40AH	50AH
Solar Panel	18V80W	18V100W	18V145W
Light Source	COB or LED Module		
Light Distribution	Bat-Wing light distribution (150°x75°)		
Light Efficiency	110-150LM/W		
Color Temperature	3000K-6000K		
CRI	≥Ra70		
IP Rating	IP65		
Working Temperature	-10°C-+60°C		
LED Lifespan	50000H-100000H		
Controller	6A30W	6A30W	10A60W
Lamp Pipe Diameter	Φ76MM		
Lamp Dimension	368x1210x68MM	387x1352x68MM	550x1480x68MM
Suggested Mount Height	4-6M	6-8M	8M
Motion Sensor	Yes		
Lamp Weight	12.3KG	15.4KG	19.2KG
Package Dimension (Sleeve not included)	455x1295x125MM	455x1575x125MM	625x1560x125MM
Warranty	3 Years		



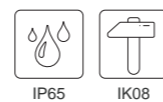

GROOT 20W/40W



ALL IN ONE SOLAR STREET LIGHT

High quality monocrystalline silicon material, high charging efficiency, long lifespan. Moisture-proof and waterproof, high quality LED lamp with wide lighting range.

Model No.	GROOT-001	GROOT-002	GROOT-003
Rated Power	20W	40W	40W
System Voltage	DC12.8V	DC12.8V	DC12.8V
LiFePO4 Battery	24AH	36AH	48AH
Solar Panel	75W	95W	95W
Light Source	3030		
Light Distribution	Bat-Wing light distribution (150°x75°)		
Light Efficiency	110-150LM/W		
Color Temperature	3000K-6000K		
CRI	≥Ra70		
IP Rating	IP65		
Working Temperature	-10°C+60°C		
LED Lifespan	50000H-100000H		
Controller	6A30W		8A40W
Lamp Pipe Diameter	Φ60MM		
Lamp Dimension	390x1262MM	390x1550MM	390x1550MM
Lamp Weight	11.6KG	13.45KG	14.45KG
Package Dimension (Sleeve not included)	465x1335x145MM	465x1625x145MM	465x1625x145MM
Suggested Mount Height	4-6M	6-8M	6-8M
Warranty	3 Years		

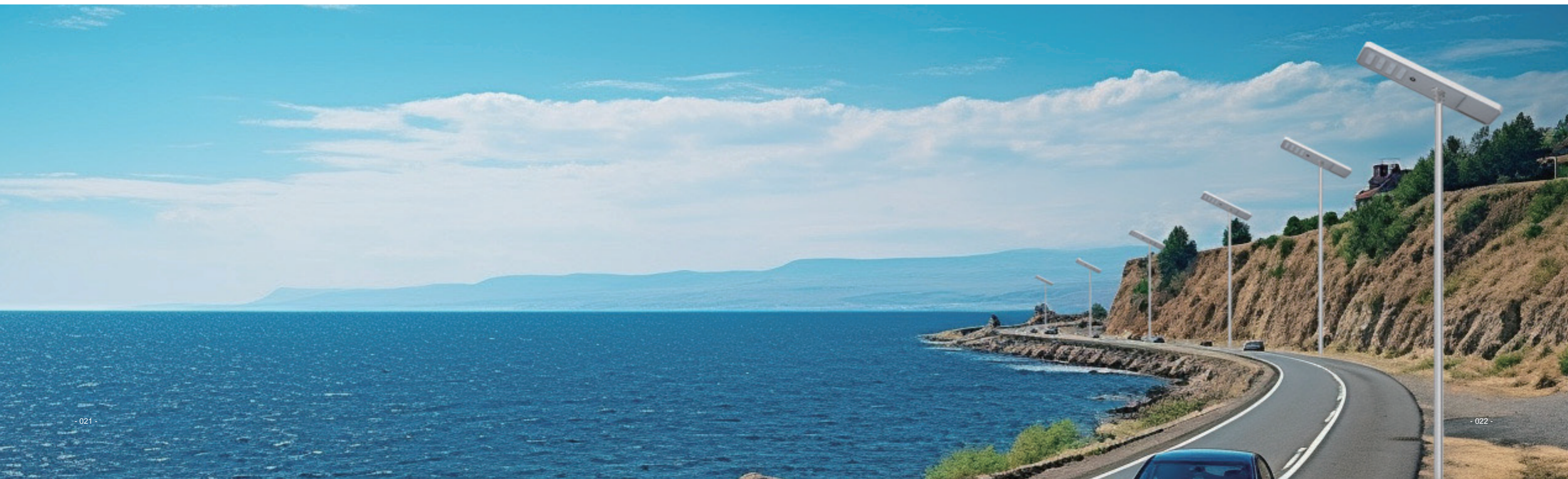

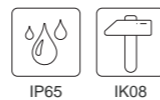

ARES 20W/25W/30W



ALL IN ONE SOLAR STREET LIGHT

Lens with a special design that is highly brilliant and light transmitting.
 Mono. panels exhibit exceptional stability and efficiency in photoelectric conversion.
 Long-lasting lithium iron phosphate battery with extended power.
 Heat-resistant, daylight-sensing, human body-sensing, and other intelligent sensors.
 Multi-angle installation that works well at various latitudes with direct sunlight angles.



Model No.	ARES-001	ARES-002	ARES-003
Rated Power	20W	25W	30W
System Voltage	DC3.2V	DC3.2V	DC3.2V
LiFePO4 Battery	40AH	40AH	50AH
Solar Panel	Mono. 45W	Mono. 60W	Mono. 70W
Light Source	5050		
Light Distribution	Bat-Wing light distribution (150°x75°)		
Light Efficiency	130-160LM/W		
Color Temperature	3000K-6000K		
CRI	≥Ra70		
IP Rating	IP65		
Working Temperature	-10°C-+60°C		
LED Lifespan	50000H-100000H		
Controller	15A20W	15A20W	20A30W
Lamp Pipe Diameter	Φ76MM		
Lamp Dimension	361x697MM	361x846MM	361x1096MM
Lamp Weight	6.45KG	8.2KG	9.15KG
Package Dimension (Sleeve not included)	435x775x165MM	432x925x165MM	435x1175x165MM
Suggested Mount Height	3-6M	3-6M	5-6M
Warranty	3 Years		



ALL IN ONE
SOLAR
STREET LIGHT

BEAM-A



- Function**
- ◆ Photocell sensor
 - ◆ Radar sensor
 - ◆ Remote control

BEAM-A

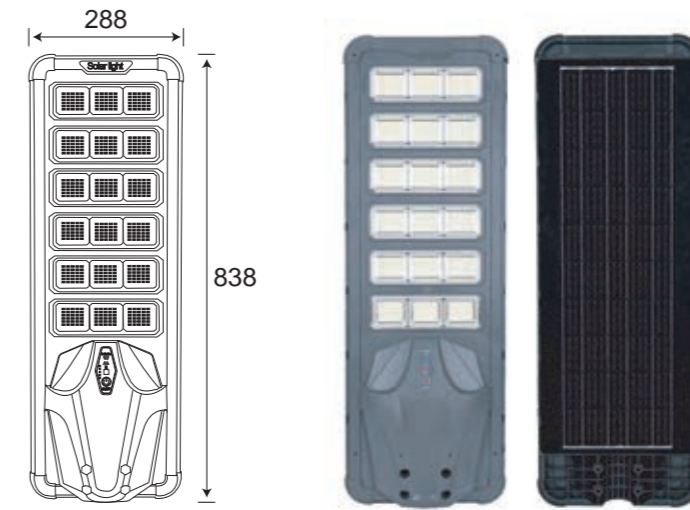

PRODUCT ADVANTAGES AND FEATURES

- ◆ Highlight
- ◆ ABS
- ◆ IP65
- ◆ New Battery

SPECIFICATION

Model	BEAM-A-001	BEAM-A-002	BEAM-A-003	BEAM-A-004	BEAM-A-005
Power	100W	200W	300W	400W	500W
Solar Panel	Mono.6V10W	Mono.6V15W	Mono.6V18W	Mono.6V25W	Mono.6V35W
Panel Size	383*194MM	508*231MM	605*233MM	580*280MM	700*280MM
Battery	3.2V/5AH	3.2V/10AH	3.2V/15AH	3.2V/20AH	3.2V/25AH
LED Chips	5730/216pcs	5730/288pcs	5730/360pcs	5730/450pcs	5730/540pcs
Color Temperature	6500K				
Material	ABS				
IP Grade	IP65				
Control	Light Control+Radar Sensor+Remote Control				
Lamp Dimension	515x215x48MM	630x235x48MM	722x237x48MM	715x285x48MM	835x285x48MM
Package Dimension	460x36x545CM/ 10pcs/CTN	500x360x655CM/ 10pcs/CTN	510x360x750CM/ 10pcs/CTN	360x310x740CM/ 5pcs/CTN	360x310x860CM/ 5pcs/CTN

PRODUCT MODE

Photocell sensor + Radar sensor + Remote control

ALL IN ONE
SOLAR
STREET LIGHT

BEAM-B



Function

- ◆ Photocell sensor
- ◆ Radar sensor
- ◆ Remote control

BEAM-B

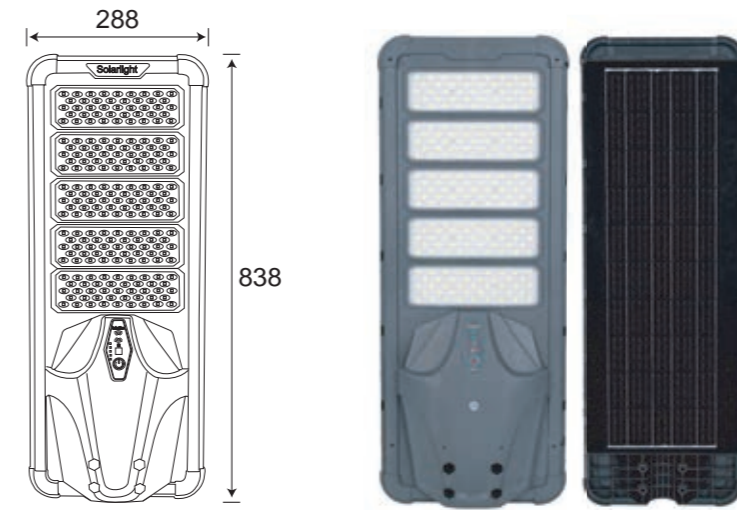

PRODUCT ADVANTAGES AND FEATURES

- ◆ Highlight
- ◆ ABS
- ◆ IP65
- ◆ New Battery

SPECIFICATION

Model	BEAM-B-001	BEAM-B-002	BEAM-B-003	BEAM-B-004	BEAM-B-005
Power	100W	200W	300W	400W	500W
Solar Panel	Mono.6V10W	Mono.6V15W	Mono.6V18W	Mono.6V25W	Mono.6V35W
Panel Size	383*194MM	508*231MM	605*233MM	580*280MM	700*280MM
Battery	3.2V/5AH	3.2V/10AH	3.2V/15AH	3.2V/20AH	3.2V/25AH
LED Chips	5054/93pcs	5054/124pcs	5054/155pcs	5054/215pcs	5054/258pcs
Color Temperature	6500K				
Material	ABS				
IP Grade	IP65				
Control	Light Control+Radar Sensor+Remote Control				
Lamp Dimension	515x215x48MM	630x235x48MM	722x237x48MM	715x285x48MM	835x285x48MM
Package Dimension	460x36x545CM/ 10pcs/CTN	500x360x655CM/ 10pcs/CTN	510x360x750CM/ 10pcs/CTN	360x310x740CM/ 5pcs/CTN	360x310x860CM/ 5pcs/CTN

PRODUCT MODE

Photocell sensor + Radar sensor + Remote control



All in Two Solar Street Light



SOLO E 12W/15W/20W/27W



ALL IN TWO SOLAR STREET LIGHT

No wiring required, install anywhere you want.
Thickened aluminum lamp body, fast heat dissipation.
Newly detachable design, easy for installation & maintenance.

Model No.	SOLO E-001	SOLO E-002	SOLO E-003	SOLO E-004
Rated Power	12W	15W	20W	27W
System Voltage	DC3.2V	DC3.2V	DC3.2V	DC3.2V
LiFePO4 Battery	36AH	48AH	60AH	84AH
Light Source	3030			
Light Distribution	Bat-Wing light distribution (150°x75°)			
Light Efficiency	110-150LM/W			
Color Temperature	3000K-6000K			
CRI	≥Ra70			
IP Rating	IP65			
Working Temperature	-10°C~+60°C			
LED Lifespan	50000H-100000H			
Mount Diameter	Φ60MM			
Lamp Dimension	530x210x95MM			
Lamp Weight	1.9KG	2.15KG	2.4KG	2.9KG
Package Dimension	585x265x225MM	585x265x225MM	585x265x225MM	585x265x225MM
Suggested Mount Height	4-6M	4-6M	4-6M	6M
Warranty	3 Years			



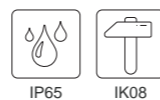
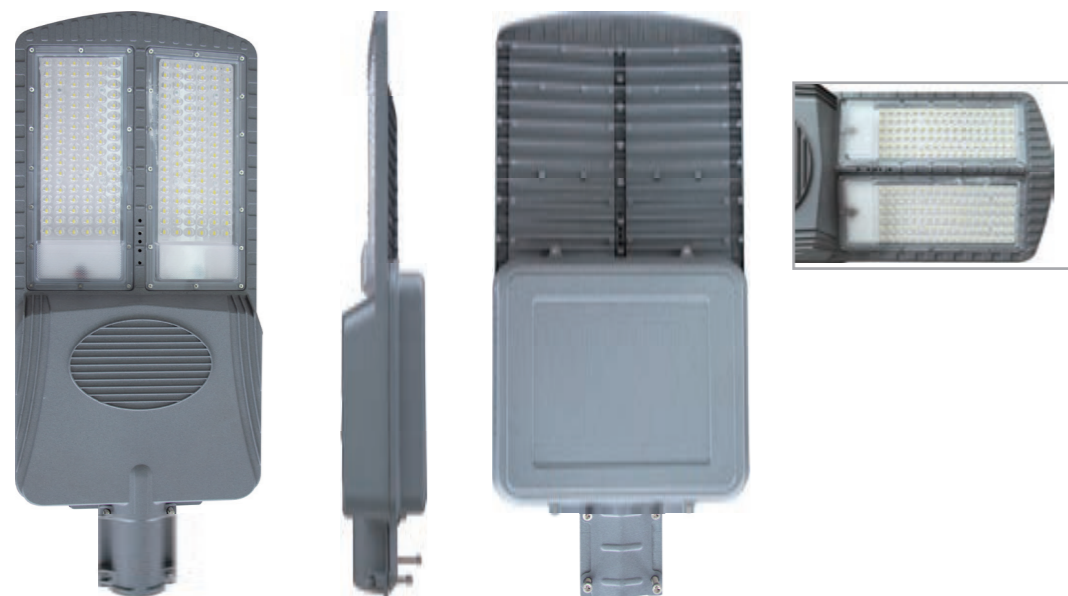

SOLO E II 16W/24W/30W/40W/54W/60W



ALL IN TWO SOLAR STREET LIGHT

Integrated design, modular production.
 The large lamp beads with lens have better condensing, brighter and wider irradiation area.
 Illuminated from different directions, wide illumination range.
 High photoelectric conversion efficiency, can be charged even in rainy days.
 The shell is made of die-cast aluminum, which has good protect.



Model No.	SOLO E II-001					
Rated Power	16W	24W	30W	40W	40W	54W
System Voltage	DC3.2V					
LiFePO4 Battery	40AH*2	50AH*2	60AH*2	80AH*2	100AH*2	120AH*2
Light Source	5050					
Light Distribution	Bat-Wing light distribution (150°x75°)					
Light Efficiency	110-160LM/W					
Color Temperature	3000K-6000K					
CRI	≥Ra70					
IP Rating	IP65					
Working Temperature	-10°C~+60°C					
LED Lifespan	50000H-100000H					
Mount Diameter	Φ60MM					
Lamp Dimension	730x310x90MM					
Lamp Weight	4.1KG	4.6KG	5.1KG	7.15KG	7.45KG	9.25KG
Package Dimension (Sleeve not included)	820x310x155MM		820x310x155MM		820x310x155MM	
Suggested Mount Height	4-6M			6M	6-8M	
Warranty	3 Years					

Model No.	SOLO E II-002			SOLO E II-003			
Rated Power	30W	40W	60W	30W	40W	40W	60W
System Voltage	DC11.1V			DC12.8V			
LiFePO4 Battery	30AH	38AH	60AH	24AH	36AH	40AH	48AH
Light Source	5050						
Light Distribution	Bat-Wing light distribution (150°x75°)						
Light Efficiency	110-160LM/W						
Color Temperature	3000K-6000K						
CRI	≥Ra70						
IP Rating	IP65						
Working Temperature	-10°C~+60°C						
LED Lifespan	50000H-100000H						
Mount Diameter	Φ60MM						
Lamp Dimension	730x310x90MM						
Lamp Weight	5.05KG	5.09KG	7.06KG	5.21KG	6.20KG	7.47KG	7.19KG
Package Dimension (Sleeve not included)	820x310x155MM			820x310x155MM		820x310x155MM	
Suggested Mount Height	6-8M			6-8M			
Warranty	3 Years						



SOLO E III

12W/15W/20W/30W/36W/40W



ALL IN TWO SOLAR STREET LIGHT

Low voltage design, safe and reliable.
 Multiple wide angles, illumination from different directions, wide lighting range.
 High photoelectric conversion efficiency, can be charged even in rainy days.
 Contains protection circuit and anti-leakage settings, stable voltage.
 Use large lens beads for better brightness.

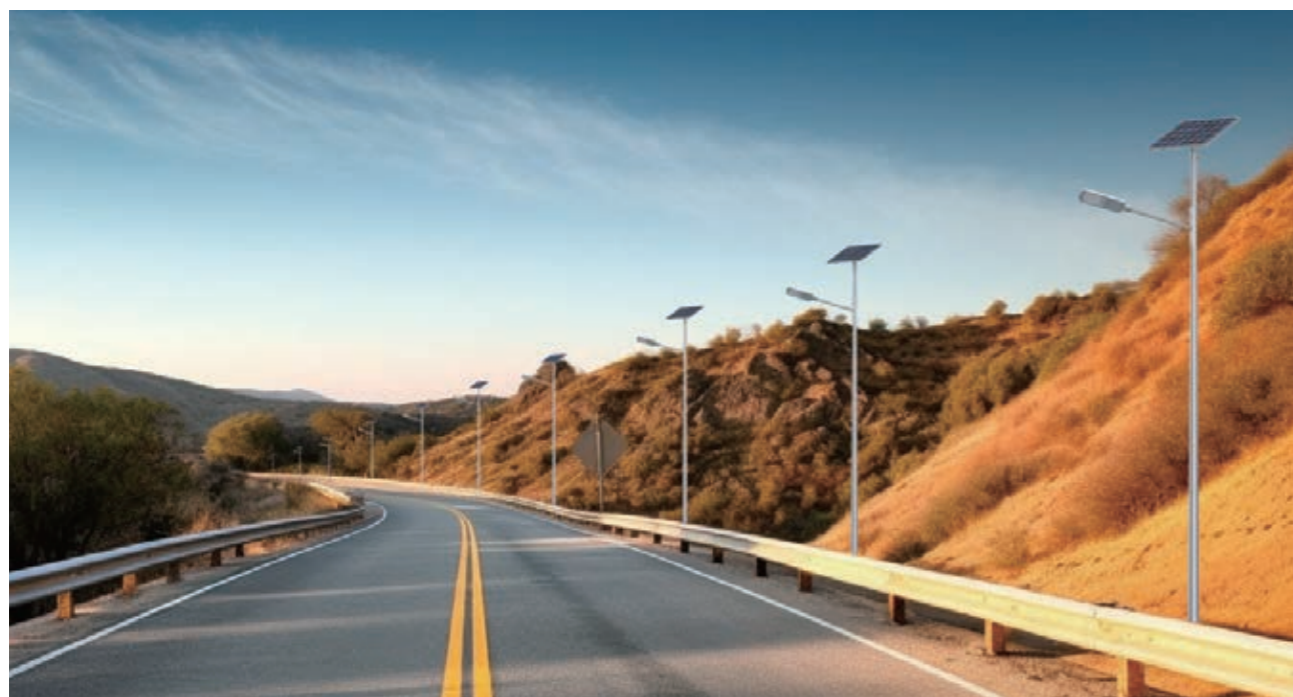

Model No.	SOLO E III-001						SOLO E III-002		SOLO E III-003	
Rated Power	12W	15W	20W	20W	30W	36W	30W	40W	30W	40W
System Voltage	DC3.2V						DC11.1V		DC12.8V	
LiFePO4 Battery	40AH	50AH	60AH	80AH	100AH	120AH	30AH	40AH	24AH	36AH
Light Source	5050									
Light Distribution	Bat-Wing light distribution (150°x75°)									
Light Efficiency	110-160LM/W									
Color Temperature	3000K-6000K									
CRI	≥Ra70									
IP Rating	IP65									
Working Temperature	-10°C--+60°C									
LED Lifespan	50000H-100000H									
Mount Diameter	Φ60MM									
Lamp Dimension	590x220x90MM									
Lamp Weight	2.25KG	2.5KG	2.7KG	3.2KG	3.45KG	3.95KG	3.9KG	4.29KG	4.06KG	5.04KG
Package Dimension (Sleeve not included)	620x330x270MM									
Suggested Mount Height	4-6M			6M		6-8M				
Warranty	3 Years									





Hoop Clamp-Mount Type and Wall-Mount Type

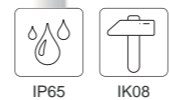

BEAN

12W/15W/20W



ALL IN TWO SOLAR STREET LIGHT

Adopt imported high lumen chip, increase current, make LED brighter and more stable, longer life, durable, transparent and waterproof.

Model No.	BEAN-001	BEAN-002	BEAN-003
Rated Power	12W	15W	20W
System Voltage	DC3.2V		
LiFePO4 Battery	40AH	50AH	60AH
Light Source	5050		
Light Distribution	Bat-Wing light distribution (150°x75°)		
Light Efficiency	110-160LM/W		
Color Temperature	5700K		
CRI	≥Ra70		
IP Rating	IP65		
Working Temperature	-10°C-+60°C		
LED Lifespan	50000H-100000H		
Mount Diameter	Φ60MM		
Lamp Dimension	495x210x95MM		
Lamp Weight	2.25KG	2.5KG	2.75KG
Package Dimension	515x270x235MM		
Suggested Mount Height	4-6M		
Warranty	3 Years		



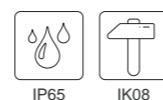

AIRCRAFT 12W/15W/20W/27W



ALL IN TWO SOLAR STREET LIGHT

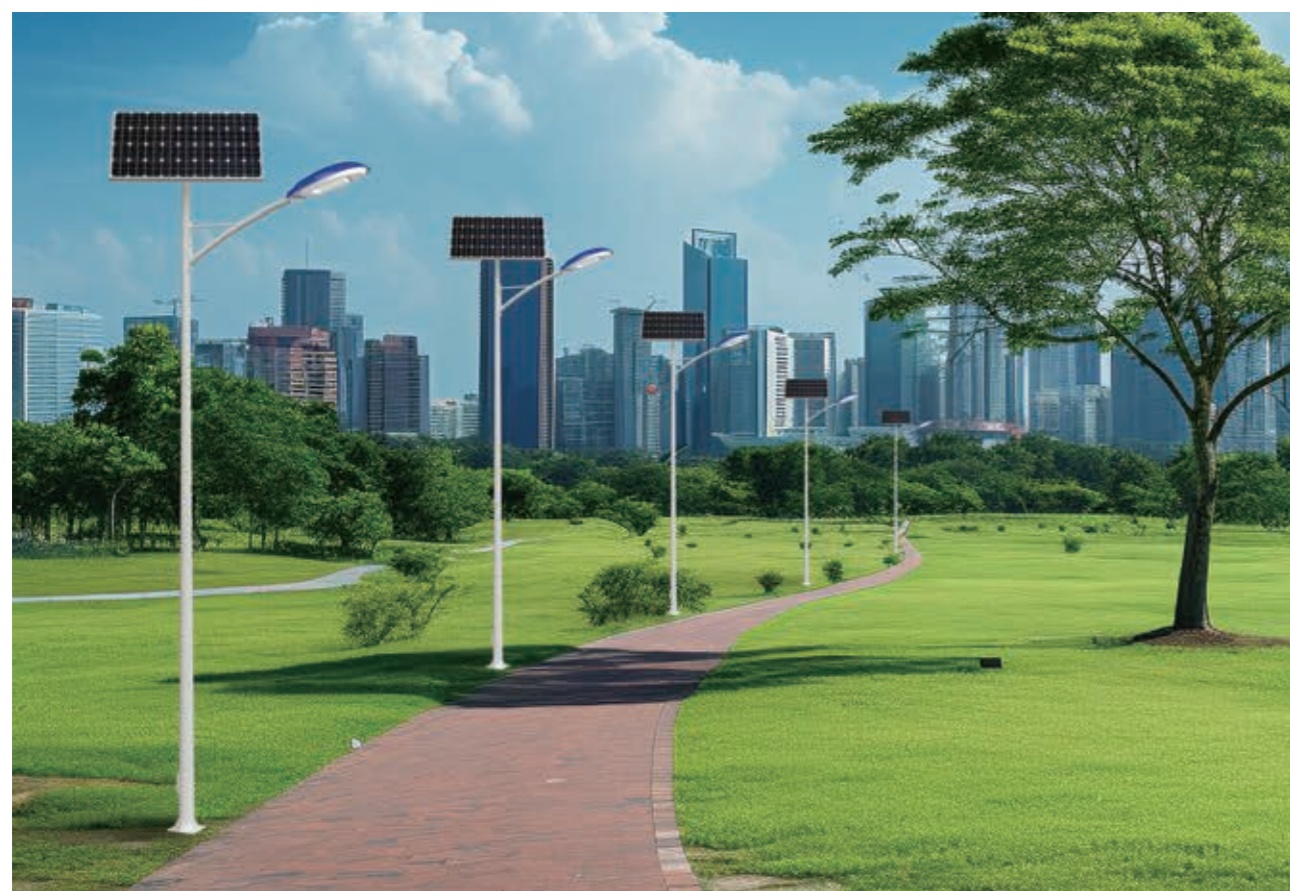

Model No.	AIRCRAFT-001	AIRCRAFT-002	AIRCRAFT-003	AIRCRAFT-004
Rated Power	12W	15W	20W	27W
System Voltage	DC3.2V			
LiFePO4 Battery	40AH	50AH	60AH	80AH
Light Source	3030			
Light Distribution	Bat-Wing light distribution (150°x75°)			
Light Efficiency	110~150LM/W			
Color Temperature	5700K			
CRI	≥Ra70			
IP Rating	IP65			
Working Temperature	-10°C~+60°C			
Working humidity	10%-90%RH			
LED Lifespan	50000H~100000H			
Mount Diameter	Φ60MM			
Lamp Dimension	635x290x120MM			
Lamp Weight	3.0KG	3.25KG	3.5KG	4.0KG
Package Dimension	660x300x200MM			
Suggested Mount Height	4-6M			
Warranty	3 Years			





Hoop Clamp-Mount Type and Wall-Mount Type

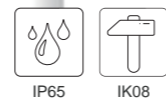

COMPACT

12W/15W/20W/25W/30W



ALL IN TWO SOLAR STREET LIGHT

Innovative lens, bat wing type light source to make a more uniform light distribution, Intelligent control system to customize illumination and reduce the power consumption, Patented support arm, easy installation and maintenance, LiFePo4 Lithium battery, longer lifespan and safer use, Longer cycles, economical and practical.

Model No.	COMPACT-001	COMPACT-002	COMPACT-003	COMPACT-004	COMPACT-005
Rated Power	12W	15W	20W	25W	30W
System Voltage	DC3.2V				
Lithium Battery	40AH	50AH	60AH	80AH	100AH
Light Source	3030				
Light Distribution	Bat-wing light distribution(150°x75°)				
Light Efficiency	≥160LM/W				
Color Temperature	3000K/4000K/5700K/6500K				
CRI	≥Ra70				
IP Grade	IP65				
IK Grade	IK08				
Working Temperature	-10°C~+60°C				
Mount Diameter	Φ48MM				
LED Lifespan	>50000H				
Lamp Dimension	585x260x105MM				
Package Dimension	595x270x220MM(2pcs/CTN)				
Mounting Method	Hoop Clamp-Mount Type and Wall-Mount Type				
Working Mode	6-12H				
Lamp Weight	4.2KG	4.2KG	4.4KG	5.3KG	5.35KG
Suggested Mount Height	4-6M				
Warranty	3 Years				





Split Solar Street Light & AC LED Street Light

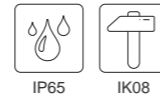

STELLAR 30W/40W/50W/60W/80W



DC/AC LED STREET LIGHT

This lamp is compatible with solar and grid-powered systems, allowing you to customize it according to your needs. Energy-saving and efficient LED light beads, continuous and stable, longer life. Adopting environmentally friendly materials, anti-oxidation, prolonging the use of time. Good large heat dissipation holes. Multiple installation methods to cope with various scenes.



Model No.	STELLAR-DC-001	STELLAR-DC-002	STELLAR-DC-003	STELLAR-DC-004	STELLAR-DC-005
Rated Power	30W	40W	50W	60W	80W
System Voltage	DC30V			DC48V	
Light Source	3030	3030	3030	3030	5050
Light Distribution	Bat-Wing light distribution (150°×75°)				
Light Efficiency	130~160LM/W				
Color Temperature	3000K~5000K				
CRI	≥Ra70				
IP Rating	IP65				
Working Temperature	-10°C~+60°C				
Working Humidity	10%-90%RH				
LED Lifespan	50000H-100000H				
Mount Diameter	Φ60MM				
Lamp Dimension	535×240×90MM				
Lamp Weight	2.4KG				
Package Dimension (2pc/CTN)	600×200×260MM(2pcs/CTN)				
Package Dimension (4pc/CTN)	600×380×260MM(4pcs/CTN)				
Suggested Mount Height	4-6M	6-8M	7-8M	8-10M	8-11M
Warranty	3 Years				

Model No.	STELLAR-AC-001	STELLAR-AC-002	STELLAR-AC-003	STELLAR-AC-004	STELLAR-AC-005
Rated Power	30W	40W	50W	60W	80W
System Voltage	AC100-277V				
Light Source	3030	3030	3030	3030	5050
Light Distribution	Bat-Wing light distribution (150°×75°)				
Light Efficiency	≥160LM/W				
Power Supply	Mingwei/Dongling				
Color Temperature	3000K~5000K				
CRI	≥Ra70				
IP Rating	IP65				
Working Temperature	-10°C~+60°C				
Working Humidity	10%-90%RH				
LED Lifespan	50000H-100000H				
Mount Diameter	Φ60MM				
Lamp Dimension	535×240×90MM				
Lamp Weight	2.7KG	2.8KG	2.8KG	2.9KG	3.0KG
Package Dimension (2pcs/CTN)	600×200×260MM(2pcs/CTN)				
Package Dimension (4pcs/CTN)	600×380×260MM(4pcs/CTN)				
Suggested Mount Height	4-6M	6-8M	7-8M	8-10M	8-11M
Warranty	3 Years				

**GLOW**

60W/150W/200W/300W

**DC/AC LED STREET LIGHT**

This lamp is compatible with solar and grid-powered systems, allowing you to customize it according to your needs. Energy-saving and efficient LED light beads, continuous and stable, longer life. Adopting environmentally friendly materials, anti-oxidation, prolonging the use of time. Good large heat dissipation holes. Multi-module optional, meet different scene requirements.



Model No.	GLOW-DC-001	GLOW-DC-002	GLOW-DC-003	GLOW-DC-004
Rated Power	60W	150W	200W	300W
System Voltage	DC54V			
Light Source	3030			
Light Distribution	Bat-Wing light distribution (150°x75°)			
Light Efficiency	140-160LM/W			
Color Temperature	3000K~5000K			
CRI	≥Ra70			
IP Rating	IP65			
Working Temperature	-10°C~+60°C			
Working Humidity	10%-90%RH			
LED Lifespan	50000H-100000H			
Mount Diameter	Φ60MM			
Lamp Dimension	561x320x88MM		721x320x88MM	
Lamp Weight	3.8KG	4.3KG	5.5KG	6KG
Package Dimension (2pc/CTN)	580x330x180MM(2pcs/CTN)		740x330x180MM(2pcs/CTN)	
Suggested Mount Height	8-10M	8-12M	10-14M	10-16M
Warranty	3 Years			

Model No.	GLOW-AC-001	GLOW-AC-002	GLOW-AC-003	GLOW-AC-004
Rated Power	60W	150W	200W	300W
System Voltage	AC100-277V			
Light Source	3030			
Light Distribution	Bat-Wing light distribution (150°x75°)			
Light Efficiency	140-160LM/W			
Power Supply	Mingwei/Dongling			
Color Temperature	3000K~5000K			
CRI	≥Ra70			
IP Rating	IP65			
Working Temperature	-10°C~+60°C			
Working Humidity	10%-90%RH			
LED Lifespan	50000H-100000H			
Mount Diameter	Φ60MM			
Lamp Dimension	561x320x88MM		721x320x88MM	
Lamp Weight	4.3KG	5.1KG	6.3KG	7.2KG
Package Dimension (2pc/CTN)	580x330x180MM(2pcs/CTN)		740x330x180MM(2pcs/CTN)	
Suggested Mount Height	8-10M	8-12M	10-14M	10-16M
Warranty	3 Years			



TRANSFO

60W/150W/200W/300W



AC LED STREET LIGHT

This lamp is compatible with solar and grid-powered systems, allowing you to customize it according to your needs. LED chip highlights the bead, high brightness, low light decay, long service life. High color, light weakness, no stroboscopic. Using high transmittance lenses and scientific light distribution methods, high light beads, low light attenuation, and long life. Die-cast aluminum heat dissipation material and strong convection heat dissipation design improve heat dissipation performance and extend the life of the lamp body.



Model No.	TRANSFO-AC-001	TRANSFO-AC-002	TRANSFO-AC-003	TRANSFO-AC-004	TRANSFO-AC-005
Rated Power	60W	150W	150W	200W	300W
Power Supply	AC100-277V				
Light Source	3030				
Light Distribution	Bat-Wing light distribution (150°x75°)				
Light Efficiency	120-180LM/W				
Power Supply	Mingwei/Dongling				
Color Temperature	3000K-6000K				
CRI	Ra≥70				
IP Rating	IP65				
Working Temperature	-10°C+60°C				
LED Lifespan	50000H-100000H				
Mount Diameter	Φ60mm				
Lamp Dimension	640x330x101MM	640x330x101MM	720x330x101MM	720x330x101MM	800x330x101MM
Lamp Weight	4.7KG	5.4KG	5.6KG	6.0KG	6.2KG
Package Dimension (two packs)	650x340x180MM (2pcs/CTN)	650x340x180MM (2pcs/CTN)	730x340x180MM (2pcs/CTN)	730x340x180MM (2pcs/CTN)	810x340x180MM (2pcs/CTN)
Suggested Mount Height	8-10M	8-12M	8-12M	10-14M	10-16M
Warranty	3 Years				





PULSE

60W/150W/200W/300W



AC LED STREET LIGHT



Model No.	PULSE-AC-001	PULSE-AC-002	PULSE-AC-003	PULSE-AC-004
Rated Power	60W	150W	200W	300W
Power Supply	AC100-277V			
LED Junction Temperature	<60°C			
LED Efficiency	120LM/W			
Power Supply	Mingwei/Dongling			
Color Temperature	3000K/4000K/5000K/6000K			
Color Rendering	≥Ra75			
Power Factor	>0.95			
Operating Temperature	-40°C~+50°C			
IP Rating	IP65			
IK Rating	IK08			
Lamp Life	>50000H			
Lamp Weight	4.8KG	5.5KG	6KG	6.8KG
Lamp Dimension	820x365x191MM			
Warranty	3 Years			



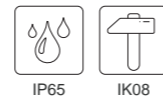

VISION

60W/150W/200W/300W



AC LED STREET LIGHT



Model No.	VISION-AC-001	VISION-AC-002	VISION-AC-003	VISION-AC-004
Rated Power	60W	150W	200W	300W
Power Supply	AC100-277V			
LED Junction Temperature	<60°C			
LED Efficiency	120LM/W			
Power Supply	Mingwei/Dongling			
Color Temperature	3000K/4000K/5000K/6000K			
Color Rendering	≥Ra75			
Power Factor	>0.95			
Operating Temperature	-40°C~+50°C			
IP Rating	IP65			
IK Rating	IK08			
Lamp Life	>50000H			
Lamp Weight	4.3KG	5.3KG	5.6KG	6.2KG
Lamp Dimension	625x350x88MM			
Warranty	3 Years			



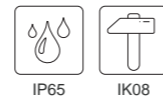

HAT 100W/120W/150W/180W



AC LED Street Light

This lamp is compatible with solar and grid-powered systems, allowing you to customize it according to your needs.
 SMD design offers high cost-performance;
 Good heat dissipation extends the lamp body's lifespan;
 Simple and attractive design with strong adaptability;
 Back cover can be opened for easy maintenance.



Model No.	HAT-AC-001	HAT-AC-002
Rated Power	100W/120W	150W/180W
System Voltage	AC100-277V	
Light Source	3030	
Light Distribution	Bat-Wing light distribution (150°×75°)	
Light Efficiency	100-160LM/W	
Power Supply	Mingwei/Dongling	
Color Temperature	3000K-6000K	
CRI	Ra≥70	
IP Rating	IP65	
Working Temperature	-10°C~+60°C	
LED Lifespan	50000H-100000H	
Mount Diameter	Φ60MM	
Lamp Dimension	630×240×125MM	670×250×125MM
Lamp Weight	3.35KG	3.95KG
Package Dimension	680×270×140MM	730×270×140MM
Suggested Mount Height	6-10M	6-12M
Warranty	3 Years	





LUMI 50W-320W



AC LED Street Light

This lamp is compatible with solar and grid-powered systems, allowing you to customize it according to your needs.
 Streamlined design, elegant and simple.
 High light effect lamp beads.
 Lamp body is easy to open for maintenance.
 Suitable for transportation roads, factories, shopping malls, parks, etc.

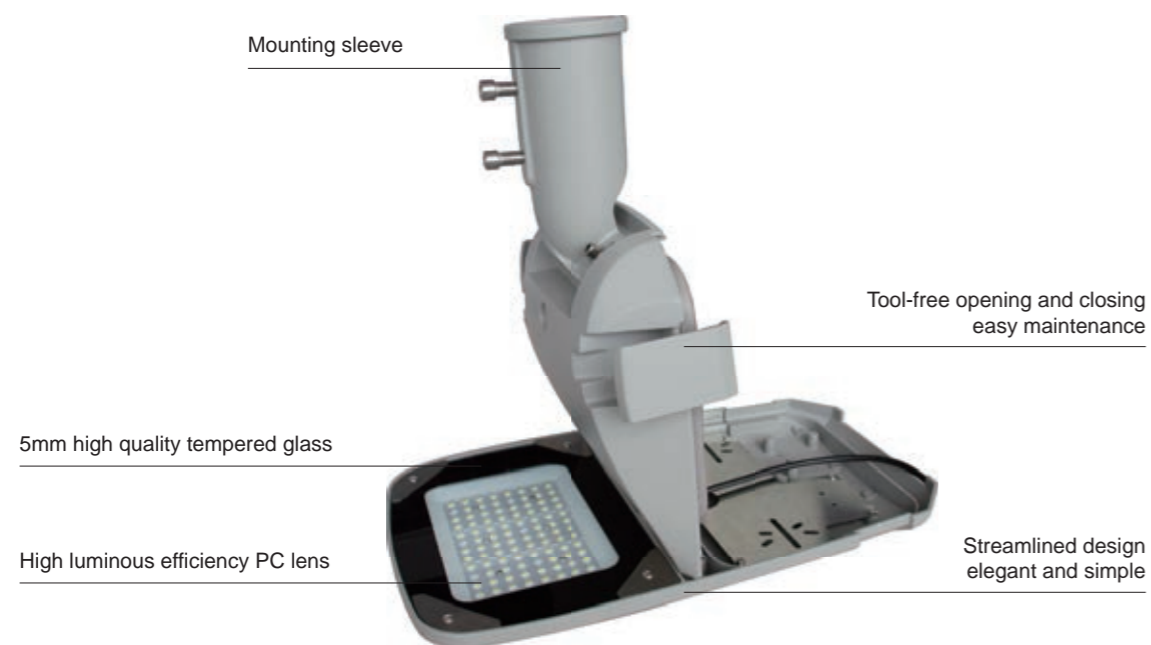

Model No.	LUMI-AC-001	LUMI-AC-002	LUMI-AC-003	LUMI-AC-004
System Voltage	AC100-277V			
Rated Power	50-80W	100-150W	150-200W	200-320W
Frequency Range	50-60Hz			
LED Junction Temperature	-45°C-60°C			
LED Efficiency	130LM/W			
Power Supply	Mingwei/Dongling			
Color Temperature	3000K/4000K/5000K/6000K			
CRI	70/75/80			
Power Factor	>0.95			
Operating temperature	-40°C-+50°C			
IP Rating	IP65			
IK Rating	IK08			
Lamp Life	>50000H			
Lamp Dimension	600×270×110MM	720×270×110MM	750×330×110MM	850×330×110MM
Warranty	3 Years			





Hoop Clamp-Mount Type and Wall-Mount Type

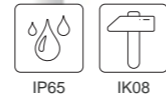

COMPACT

30W



AC LED Street Light

Patented Lens, Bat wing Type Light Source to make a more uniform light distribution, Intelligent control system to customize illumination and reduce the power consumption, Patented support arm, easy installation and maintenance, LiFePo4 Lithium battery, longer lifespan and safer use, Longer cycles, economical and practical.

Model No.	COMPACT
Rated Power	30W
System Voltage	AC100-277V
Light Source	3030
Light Distribution	Bat-wing light distribution(150°x75°)
Light Efficiency	≥160LM/W
Power Supply	Mingwei/Dongling
Color Temperature	3000K/4000K/5700K/6500K
CRI	≥Ra70
IP Grade	IP65
IP Grade	IK08
Working Temperature	-10°C~+60°C
Mount Diameter	Φ48MM
LED Lifespan	> 50000H
Lamp Dimension	585x260x105MM
Package Dimension	642x312x320MM(2pcs/CTN)
Mounting Method	Hoop Clamp-Mount Type and Wall-Mount Type
Lamp Weight	4.5KG
Suggested Mount Height	5-6M
Warranty	3 Years





Solar Light for Home

SOLAR
LIGHT

BUDDY-A/B



Function

- ◆ Photocell sensor
- ◆ Digital display
- ◆ Remote control

BUDDY-A/B

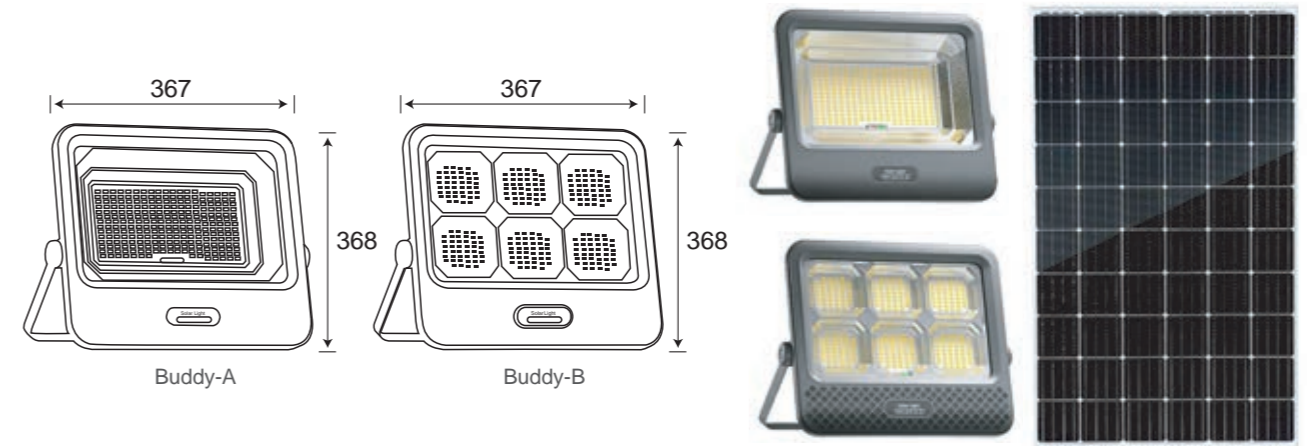

- ◆ Highlight
- ◆ ABS
- ◆ IP65
- ◆ New Battery

SPECIFICATION

Model	BUDDY-001	BUDDY-002	BUDDY-003	BUDDY-004	BUDDY-005	BUDDY-006	BUDDY-007
Power	50W	100W	200W	300W	400W	500W	600W
Solar Panel	Mono.6V3W	Mono.6V8W	Mono..6V10W	Mono.6V15W	Mono.6V8W	Mono.6V25W	Mono.6V30W
Panel Size	220*137mm	270*180MM	235*350MM	350*290MM	350*350MM	450*350MM	530*350MM
Battery	3.2V/3AH	3.2V/4AH	3.2V/5AH	3.2V/8AH	3.2V/12AH	3.2V/18AH	3.2V/24AH
LED Chips	SMD5730 77pcs	SMD5730 77pcs	SMD5730 112pcs	SMD5730 144pcs	SMD5730 252pcs	SMD5730 322pcs	SMD5730 322pcs
Material	ABS						
IP Grade	IP67						
Control	Digital Display+Photocell Sensor+Remote Control						
Charge Time	5-6H						
Discharge Time	10-15H						
Irradiation Area	80m ²	100m ²	150m ²	180m ²	200m ²	250m ²	300m ²
Lamp Dimension	209x185x57MM	209x185x57MM	254x230x62MM	281x250x68MM	337x296x68MM	368x328x68MM	368x328x68MM
Package Dimension	48.5x41.5x51.5CM/ 20pcs/CTN	53x39.5x31CM/ 12pcs/CTN	49.5x47x39.5CM/ 10pcs/CTN	64.5x40.5x37.5CM/ 12pcs/CTN	60x37.5x39.5CM/ 6pcs/CTN	51.5x47x39CM/ 5pcs/CTN	54.5x51.5x39.5CM/ 5pcs/CTN

PRODUCT MODE

Digital display + Photocell sensor + Remote control



High Mast Light

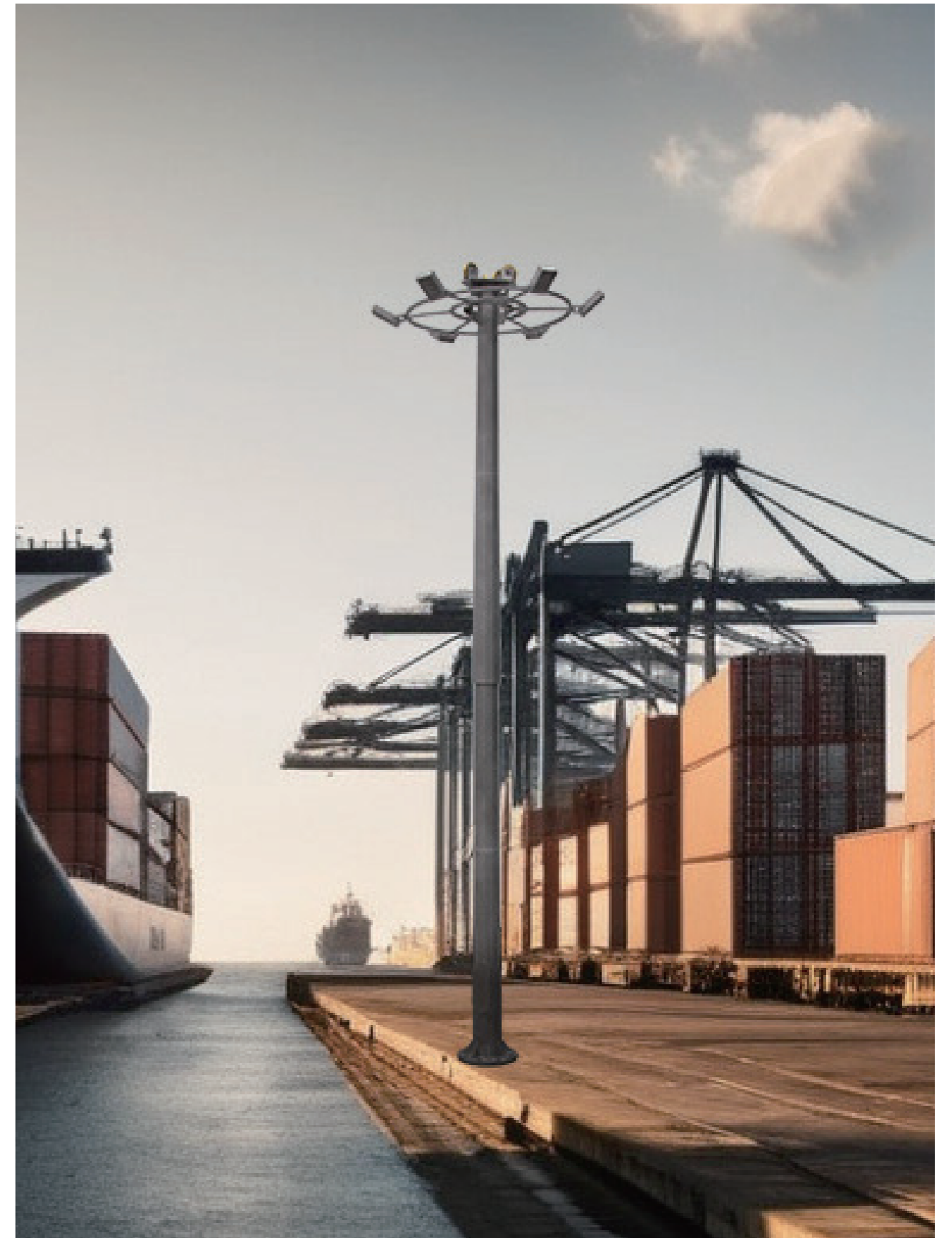
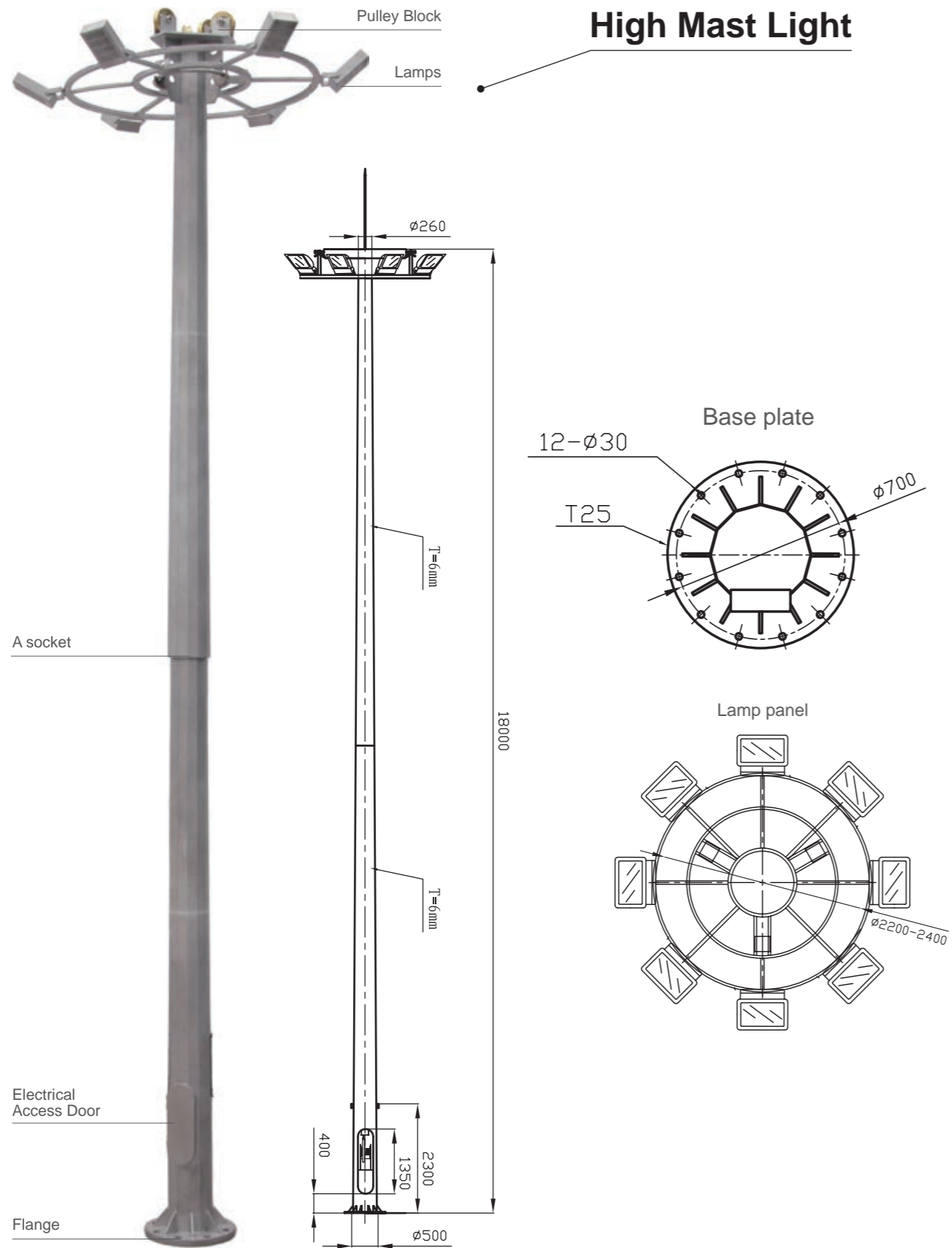

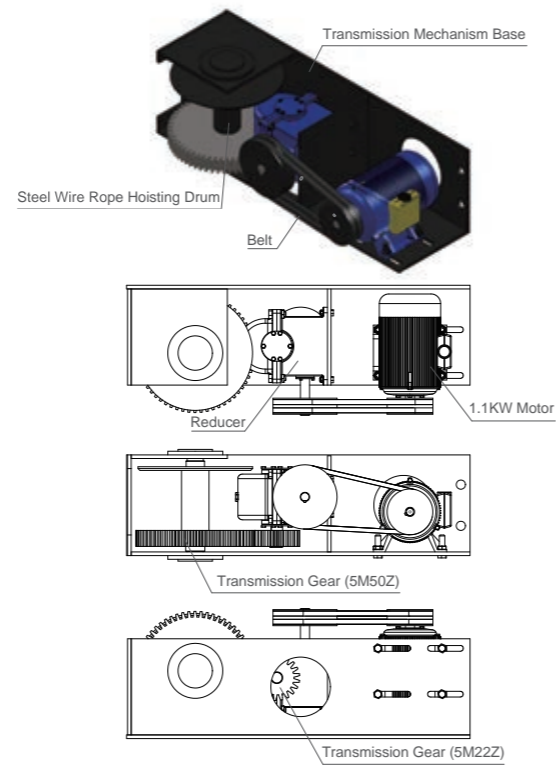
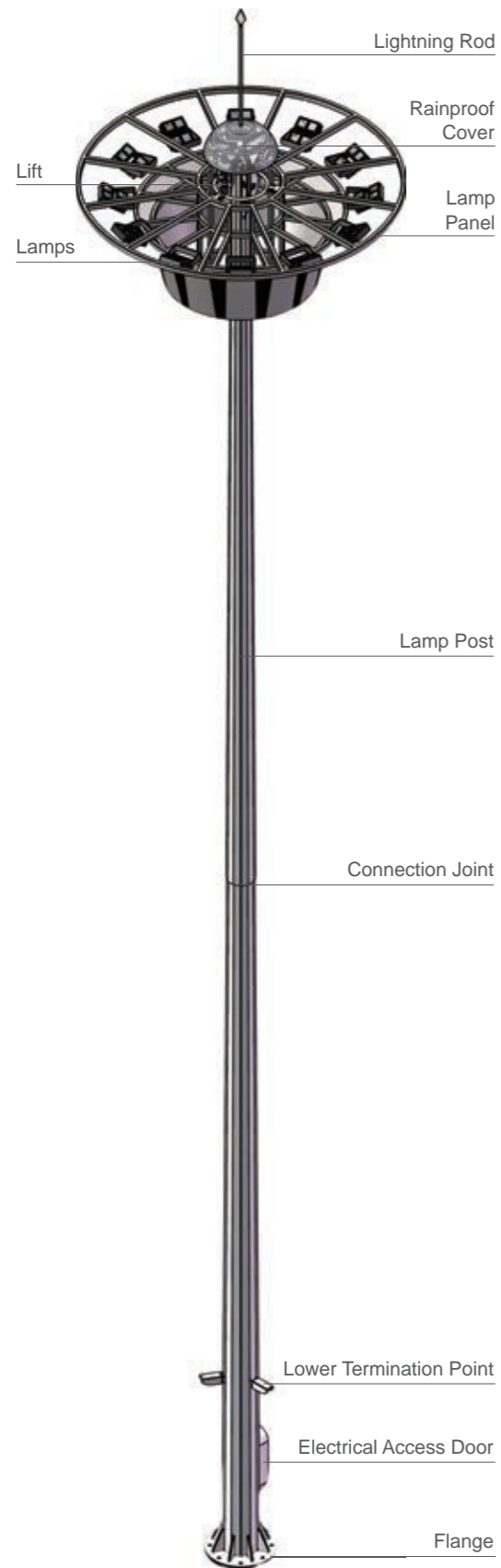

High Mast Pole with Lift System

Height(m)	Upper and lower diameters(mm)	Thickness(mm)	Flange Diameter(mm)
15	200-380	6-6/6-8	700*700*20
20	220-450	6-6/6-8	750*750*20
25	240-550	6-6-8/6-8-8/6-8-10	900*900*25
30	260-560/280-640	6-8-8/6-8-10/6-10-12	1050*1050*25/30
35	320-680	8-8-10/8-10-12	1100*1100*30
40	350-720	8-8-10-12/8-10-10-12	1200*1200*40
Applicable Scene	For large squares, sports, airports, high-speed service areas, city center intersections, etc. require large-area lighting.		

Driving Motor System	Height(m)	Weight Capacity(kg)	Power(kw)
Small	15-25	350	0.75
Mid	25-30	350-450	0.75-1
Large	30-40	450-700	1.1



Recommended Parameters

High Mast Pole with Step Ladder

Height(m)	Upper and lower diameters(mm)	Thickness(mm)	Flange Diameter(mm)
15	180-340	6-6/6-8	700*700*20
20	200-400	6-6/6-8	750*750*20
25	240-500	6-6-8/6-8-8/6-8-10	800*800*25
30	260-560	6-6-8/6-8-8/6-8-10	1000*1000*25/30
Applicable Scene	For large squares, sports, airports, high-speed service areas, city center intersections, etc. require large-area lighting.		



Recommended Parameters



SHADOW

150W/180W/200W/240W/300W



Model No.	SHADOW-001	SHADOW-002	SHADOW-003	SHADOW-004	SHADOW-005
Rated Power	150W/3 Modules	180W/3 Modules	200W/4 Modules	240W/4 Modules	300W/5 Modules
System Voltage	AC100-277V				
Light Source	3030				
Light Distribution	Bat-Wing light distribution (150°x75°)				
Light Efficiency	≥120LM/W				
Color Temperature	3000K/4000K/5000K/6000K				
CRI	≥Ra70				
IP Rating	IP66				
IK Rating	IK08				
Working Temperature	-10°C-+60°C				
Lamp Weight	5.2KG	5.2KG	6KG	6KG	7KG
LED Lifespan	> 50000H				
Lamp Dimension	430x380x63MM	430x380x63MM	510x380x63MM	510x380x63MM	590x380x103MM
Package Dimension	440x395x150MM (2pcs/CTN)	440x395x150MM (2pcs/CTN)	520x395x150MM (2pcs/CTN)	520x395x150MM (2pcs/CTN)	600x395x150MM (1pc/CTN)
Suggested Mount Height	7-10M		10-12M		12-15M
Warranty	3 Years				

High Mast Light

Tight die cast aluminum body has excellent heat dissipation, effectively prolongs lamp lifespan. Metal bracket allows flexibly installation including ceiling-mounted, wall-mounted and ground.



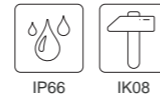

MEGA

100W/150W/180W/200W/240W/300W



Model No.	MEGA-001	MEGA-002	MEGA-003	MEGA-004	MEGA-005	MEGA-006
Rated Power	100W/2 Modules	150W/3 Modules	180W/3 Modules	200W/4 Modules	240W/4 Modules	300W/5 Modules
System Voltage	AC100-277V					
Light Source	3030					
Light Distribution	Bat-Wing light distribution (150°x75°)					
Light Efficiency	≥120LM/W					
Color Temperature	3000K/4000K/5000K/6000K					
CRI	≥Ra70					
IP Rating	IP66					
IK Rating	IK08					
Working Temperature	-10°C~+60°C					
Lamp Weight	2.3KG	4.3KG	4.3KG	5.5KG	5.5KG	6.3KG
LED Lifespan	>50000H					
Lamp Dimension	210x350x120MM	280x340x120MM	280x340x120MM	350x340x120MM	350x340x120MM	420x340x120MM
Package Dimension	290x350x130MM (1pc/CTN)			360x350x130MM (1pc/CTN)		430x350x130MM (1pc/CTN)
Suggested Mount Height	7-10M			10-12M		12-15M
Warranty	3 Years					

High Mast Light

Standard module, convenient storage, efficient radiating performance. Products are waterproof joints and silicone pad sealing process, the protection level of IP66, suitable for a variety of harsh outdoor environment.





Light Pole

RECOMMENDED LIGHT POLE PARAMETERS

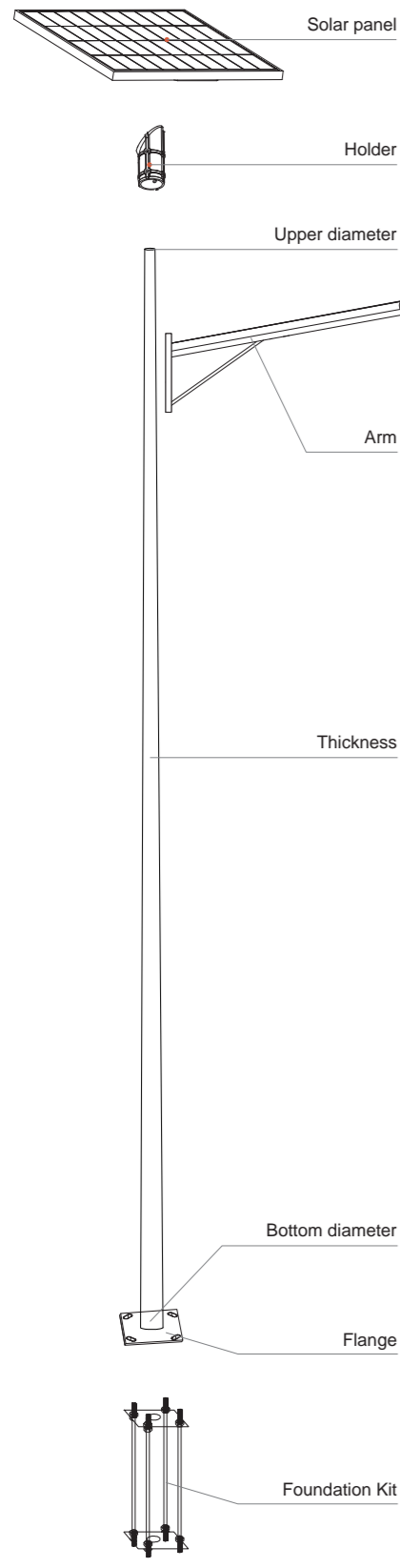

Height (mm)	Upper and bottom diameter (mm)	Thickness (mm)	Flange (mm)	Arm (mm)	Bearing area (m ²)	Suggested Foundation Kit (m ²)
6000	60-140	2.75	260*14	950*60	≤0.6	16*750
		3.00			0.6-0.8	
		3.25			0.8-1.0	
6500	60-140	2.75	260*14	950*60	≤0.6	16*750
		3.00			0.6-0.8	
		3.25			0.8-1.0	
7000	75-150	3.00	280*14	950*60	≤1.3	18*900
		3.25			≤1.5	
		3.50			≤1.5	
7500	75-175	3.00	300*14	950*60	≤1.3	18*900
		3.25			≤1.5	
		3.50			≤1.5	
8000	85-180	3.00	320*16	1100*60	≤1.3	20*1000
		3.25			≤1.5	
		3.75			≤2.0	
		4.00			≤2.6	
8500	85-180	3.00	320*16	1100*60	≤1.3	20*1000
		3.25			≤1.5	
		3.75			≤2.0	
		4.00			≤2.6	
9000	85-200	3.25	350*16	1100*60	≤2.0	20*1200
		3.50			≤2.0	
		3.75			≤2.6	
		4.00			≤3.0	
9500	85-200	3.50	350*16	1100*60	≤2.0	22*1200
		3.75			≤2.6	
		4.00			≤3.0	
10000	85-200	4.00	400*20	1400*60	≤2.6	24*1200
	90-220	4.50			≤3.0	24*1500
	100-235	5.00			≤4.0	24*1500*6
11000	90-220	4.00	400*20	1400*60	≤2.6	24*1200
	90-220	4.50			≤3.0	24*1200*6
	100-235	5.00			≤4.0	24*1500*6
11500	90-220	4.50	400*20	1400*60	≤2.6	24*1500
	90-220	5.00			≤3.0	24*1500*6
	100-235	5.00			≤4.0	24*1500*6

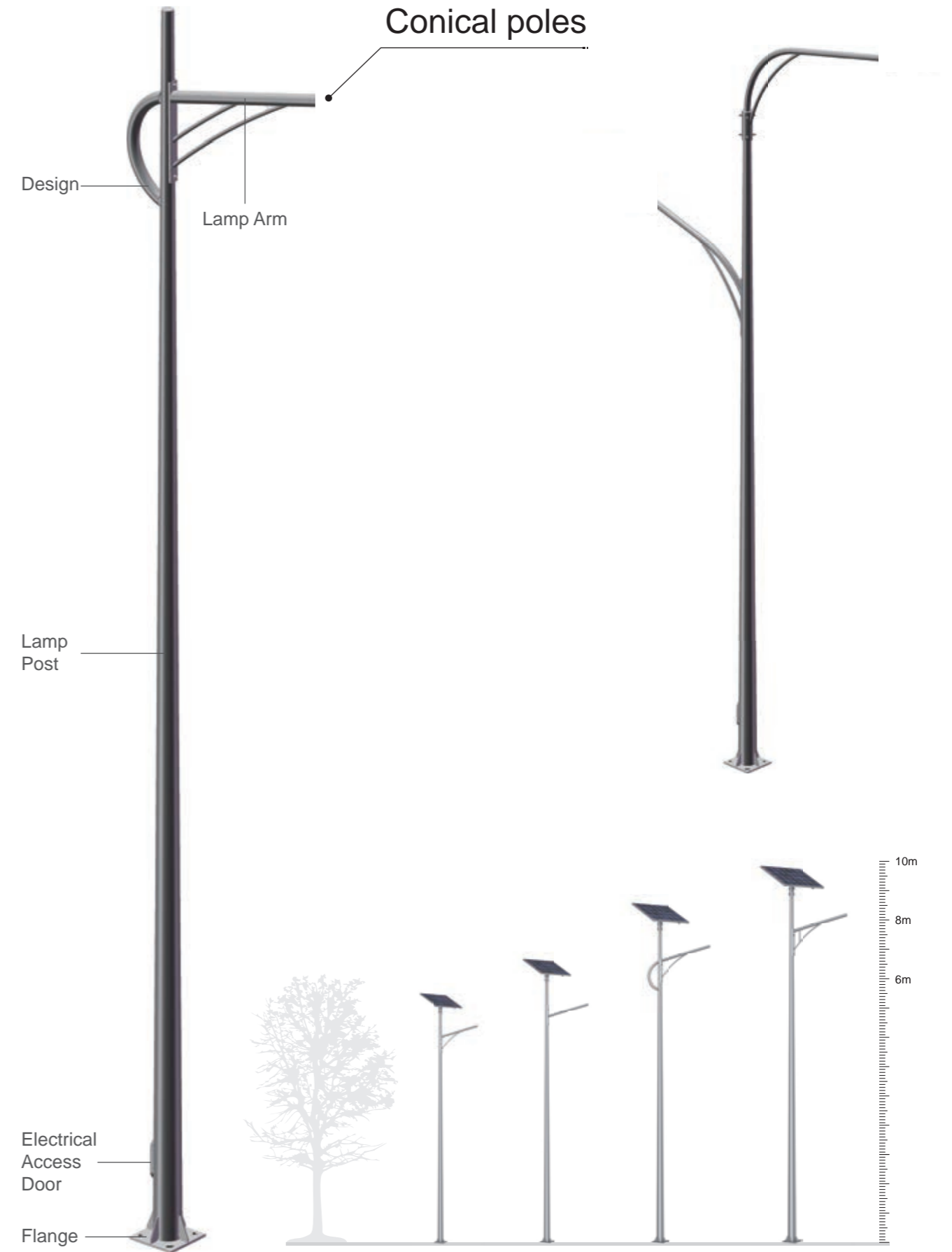



Small Traffic Monitor Poles

Material	Galvanized poles, steel poles (hot dip galvanized)
Recommended height(m)	3-4
Upper and lower diameters(mm)	76-140/89-140
Thickness(mm)	2.3/2.5/2.75
Flange Diameter(mm)	240*240*8/260*260*8/260*260*10
Arm Length(m)	0.5-1
Applicable Scene	For communities, parks, factories, and small squares



Middle Traffic Monitor Poles

Material	Steel pole (hot dip galvanized)
Recommended height(m)	4-6
Upper and lower diameters(mm)	140/165/180
Thickness(mm)	3.5/3.75/4
Flange Diameter(mm)	300*300*12/300*300*16/350*350*20
Arm Length(m)	1-2
Applicable Scene	For rural roads, main road intersections, highway card entrances and park entrances



Large Traffic Light Poles

Recommended height(m)	Poles Thickness(mm)	Poles Flange Diameter(mm)	Arm Length(m)
5-6	4.5-5	500*500*20/550*550*20	1-1.6
7-8	5-6	500*500*20/550*550*20/600*600*20	1-1.9
9-12	6-8	600*600*20/600*600*25/700*700*20	1-2.2
13-16	10	700*700*25/750*750*25/800*800*25	1.1-2.6
Arm Thickness(mm)	Arm Flange Diameter(mm)	Diameter tube main pole(mm)	
4-4.5	320*320*16/320*320*18	219, thickness 4.5-5. Cross arm 120 diameter tube + 100 square tube, thickness 4.	
4.5-5	350*350*18/350*350*20	273, thickness 5-6. Cross arm 140 diameter tube + 120 square tube, thickness 4-4.5-5.	
6-8	350*350*20/400*400*20	273, thickness 8. Cross arm 152 diameter tube + 120 square tube, thickness 5-6.	
6-8	400*400*20/450*450*20	325, thickness 8-10. Cross arm 180 diameter tube + 150 square tube, thickness 6-8.	

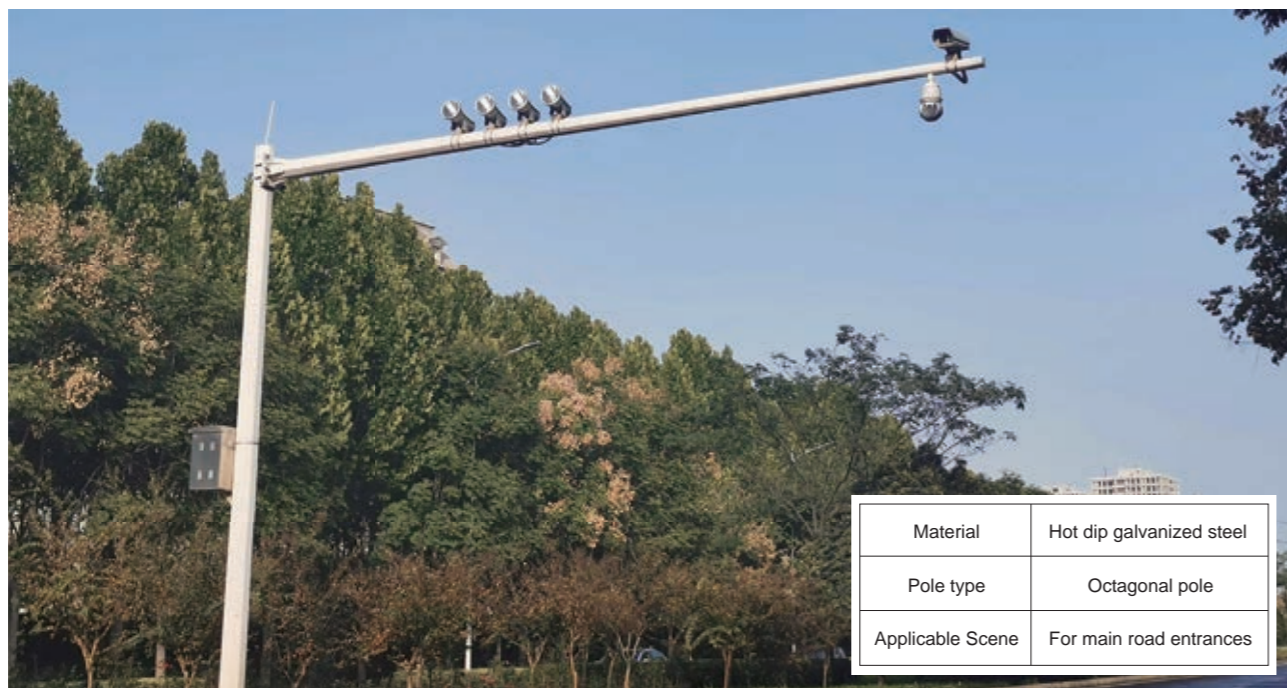

Material	Hot dip galvanized steel
Pole type	Octagonal pole
Applicable Scene	For main road entrances





Material	Hot dip galvanized
Pole type	Diameter square tube
Applicable Scene	For main road entrances

Frame Type Large Traffic Light Pole

Recommended height(m)	5-8	8-10
Poles Thickness(mm)	5	6-8
Poles Flange Diameter(mm)	600*1000*20	700*1200*20
Arm Length(m)	5-10	5-10
Arm Thickness(mm)	4	5-6
Arm Flange Diameter(mm)	180*800*16/180*800*18	200*800*18/200*800*20

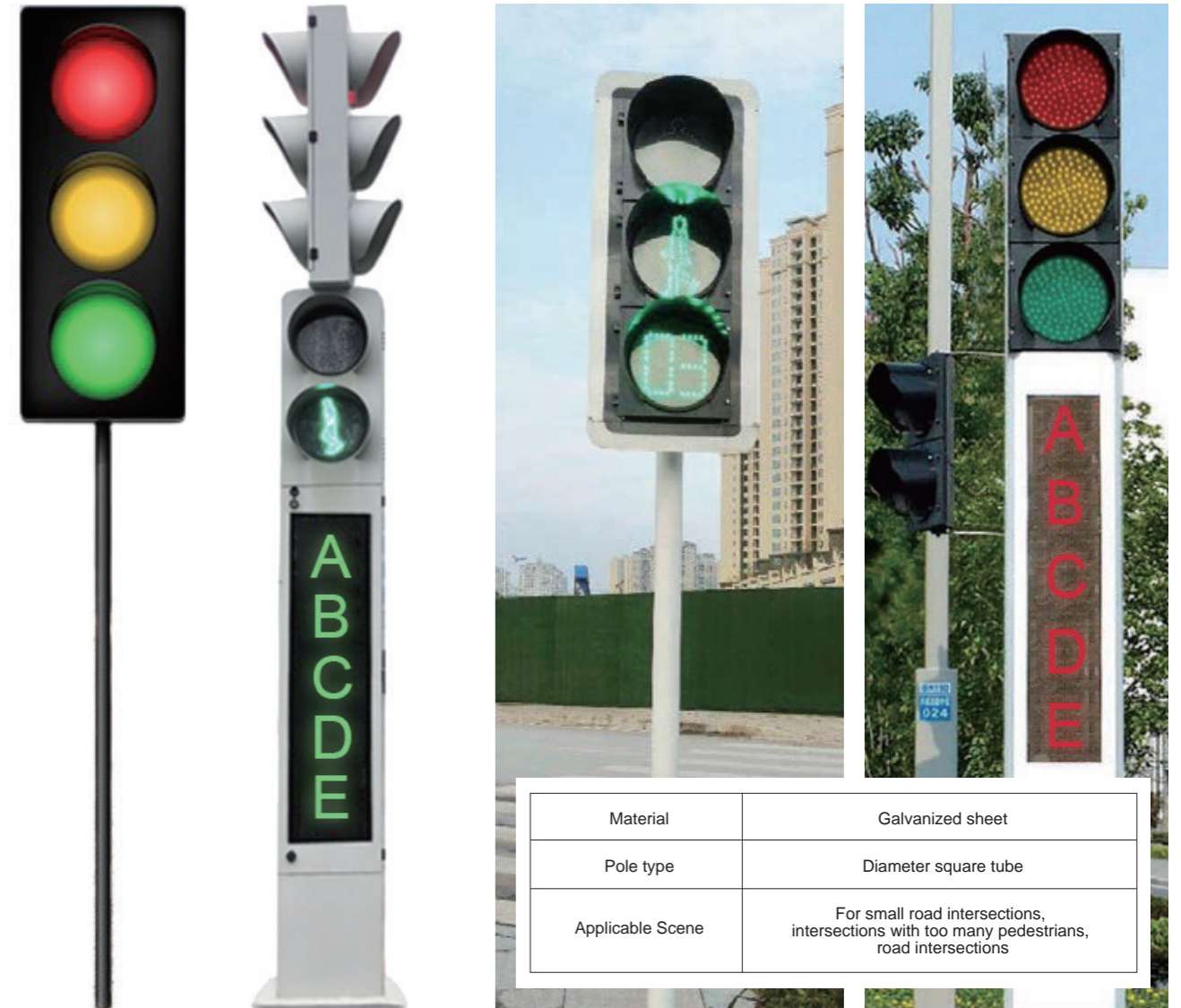

Material	Galvanized sheet
Pole type	Diameter square tube
Applicable Scene	For small road intersections, intersections with too many pedestrians, road intersections

Crosswalk Lights

Recommended height(m)	3-4
Poles Thickness(mm)	3-4
Poles Flange Diameter(mm)	320*320*16/320*320*18/350*350*18

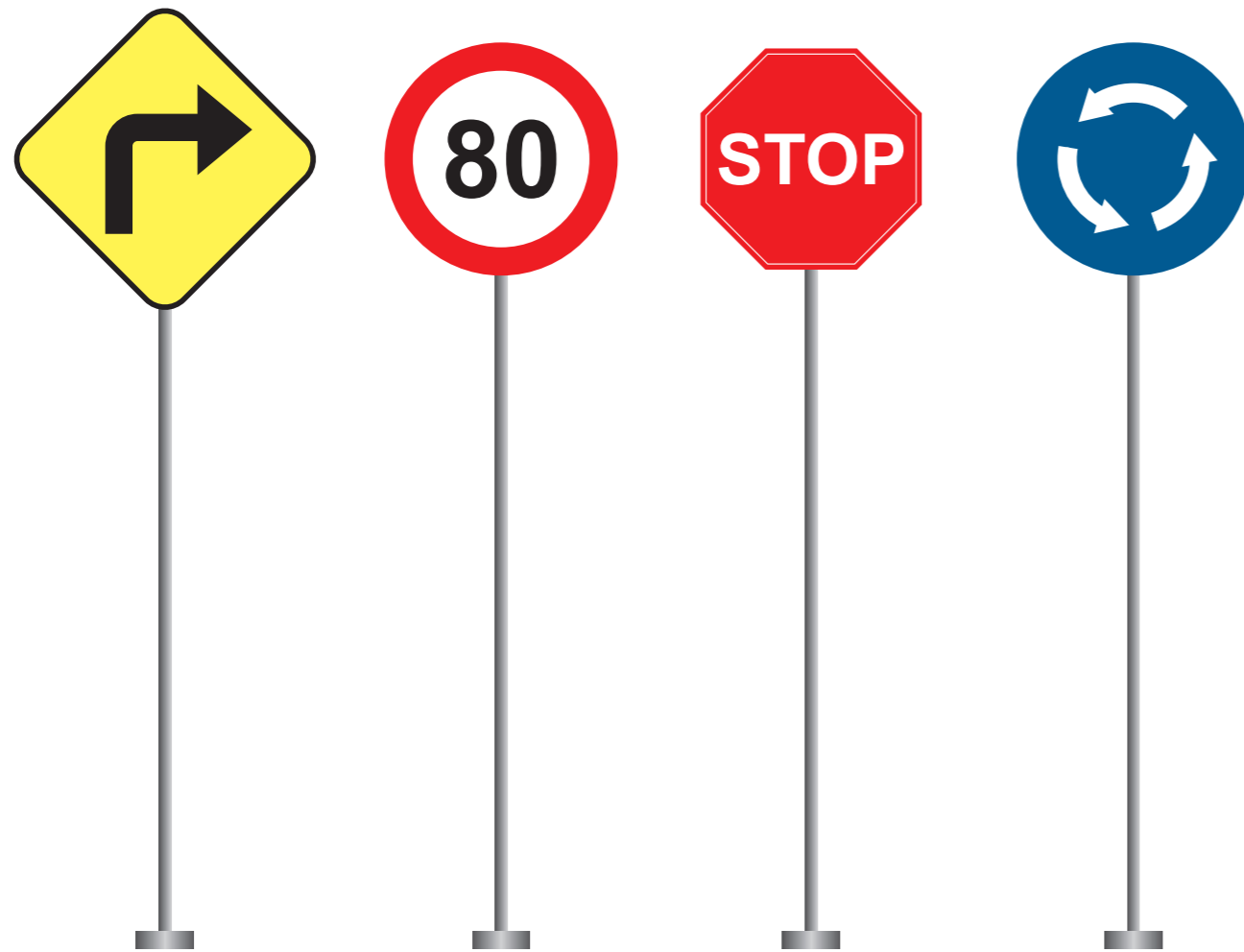

Warning Sign Poles

Recommended Height(m)	2.5-4
Pole(mm)	Diameter tube 76/89/104/140mm
Thickness(mm)	3-4-5
Flange Diameter(mm)	350*350*16/350*350*18/350*350*20
Applicable Scene	For rural roads, highway speed limits, bridge weight limits.
Requirement	Small reflective film, mainly for warning purposes.

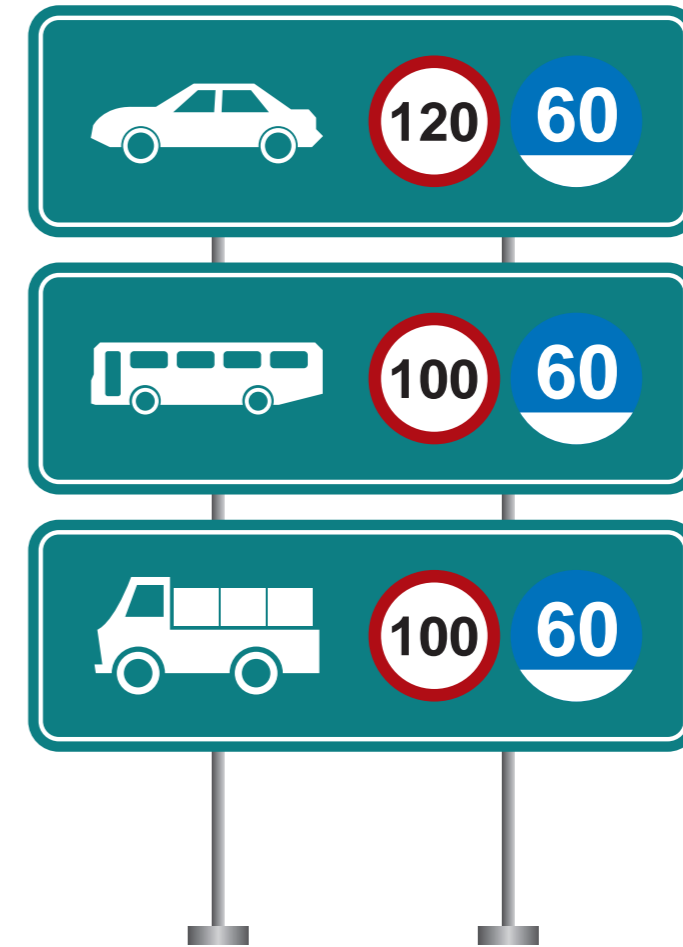

Large Warning Sign Poles

Recommended Height(m)	4-6
Pole(mm)	Diameter tube 121/165/180mm
Thickness(mm)	5-6
Flange Diameter(mm)	350*350*20/400*400*20/500*500*20
Applicable Scene	For national highway, expressway
Requirement	Large & medium reflective film(large quantity), mainly used for warning purposes



L Shaped Sign Poles

Recommended Height(m)	7.5
Pole(mm)	Diameter tube 180/219/273mm
Pole Thickness(mm)	6-8
Pole Flange Diameter(mm)	600*600*20/700*700*20/700*700*25
Arm(mm)	Diameter tube 102/120/140/160mm
Arm Thickness(mm)	5-6
Arm Flange Diameter(mm)	350*350*20
Applicable Scene	For rural roads, national roads, expressways
Requirement	Medium & small reflective film(large quantity), mainly used for warning purposes

F & Multi-F Shaped Sign Poles

Recommended Height(m)	7.5-8.5
Pole(mm)	Diameter tube 273/299/325/377mm
Pole Thickness(mm)	8-10-12
Pole Flange Diameter(mm)	800*800*20/800*800*25
Arm(mm)	Diameter tube 140/160/180mm
Arm Thickness(mm)	5-6
Arm Flange Diameter(mm)	350*350*20/400*400*20/450*450*20mm
Applicable Scene	For national roads, expressways
Requirement	Large & medium reflective film(large quantity), mainly used for warning purposes

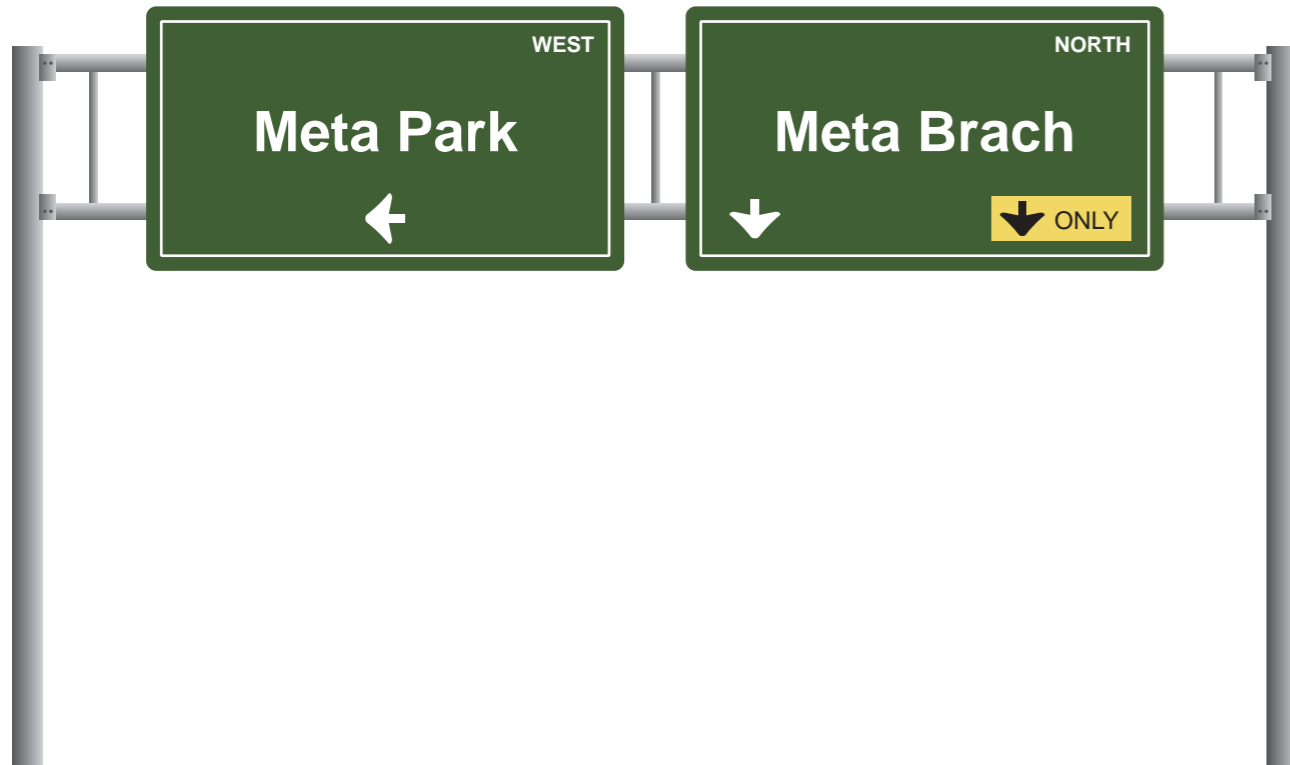

Gantry Type Sign Poles

Recommended Height(m)	8.5
Pole(mm)	Diameter tube 325/377mm
Pole Thickness(mm)	10-12
Pole Flange Diameter(mm)	700*700*25/800*800*25/700*700*30
Arm(mm)	Diameter tube 120/140/160/180mm
Arm Thickness(mm)	5-6
Arm Flange Diameter(mm)	400*400*20/400*400*25/450*450*25/500*500*25mm
Applicable Scene	For national roads, expressways
Requirement	Large reflective film(large quantity), mainly used for warning purposes

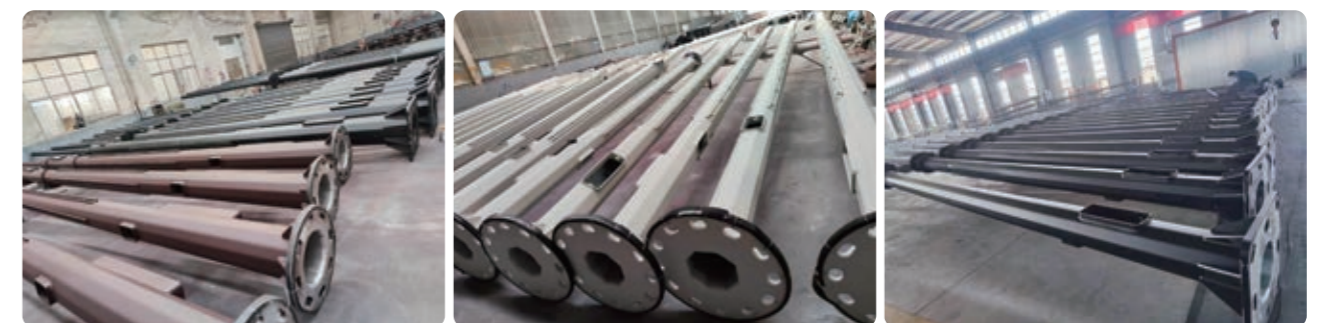
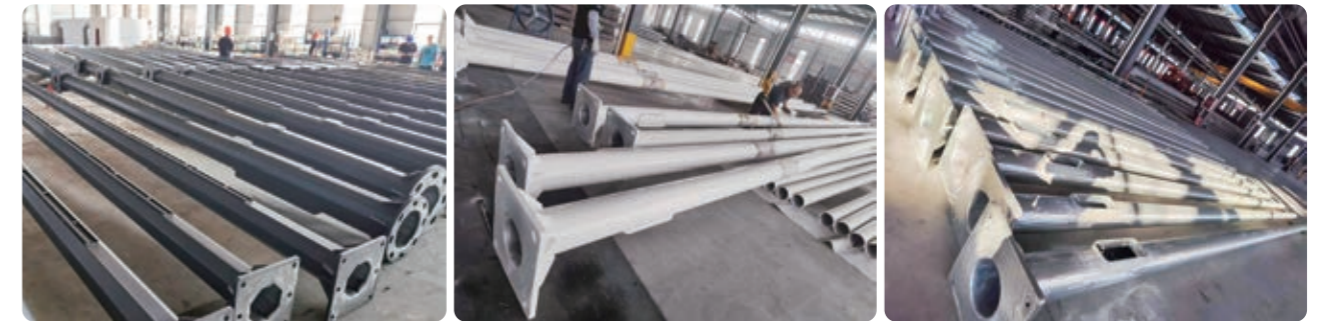

*Light pole pictures in our factory.

Outdoor Street Lights Cases



Multifunctional Poles Cases



High Mast Cases

